



Version 01

User Manual

HOME-ESS-HV-5.12K

Smart Energy,

Sustainable Solutions

All rights reserved © 2024 Jiangsu Hanchu Energy Technology Co., Ltd

No entity or individual may reproduce or excerpt any part or the entirety of this document without the written permission of our company, and it may not be transmitted in any form.

Trademark Notice

Hanchu ESS and other Hanchu trademarks are the property of Jiangsu Hanchu Energy Technology Co., Ltd.

All other trademarks or registered trademarks mentioned in this document are owned by their respective owners.

Note

The storage, use and disposal of the products shall be carried out in accordance with the user manual, relevant contract or relevant laws and regulations.

The products, services, or features you purchase are subject to the commercial contracts and terms of Jiangsu Hanchu Energy Technology Co., Ltd. All or some of the products, services, or features described in this document may not be within the scope of your purchase or use. Jiangsu Hanchu Energy Technology Co., Ltd makes no express or implied statements or warranties regarding the content of this document.

The content of this document will be periodically updated. You can check the related information on the website of Jiangsu Hanchu Energy Technology Co., Ltd.

Version 01(2024-07-08)

First release.

Contents

1. Manual Overview	1
1.1 Purpose	1
1.2 Target Audience	1
1.3 Symbol Conventions	1
2. Safety Requirements	3
2.1 General Requirements	3
2.2 Personnel Requirements	3
2.3 Installation Environment Requirements	4
2.4 Electrical Requirements	5
2.5 Personal Safety	5
2.6 Battery Safety	6
2.7 Emergency Measures	8
2.8 Battery Recovery Process	9
2.9 EU Declaration of Conformity	9
3. Product Description	10
3.1 Product Description	10
3.2 Interface Description	15
3.3 Symbol Explanation	16
4. Installation	18
4.1 Installation Note	18
4.2 Installation Preparation	20
4.3 Installation	22
4.4 Electrical Connections	26
4.5 Communication Connection	30
4.6 Equipment Debugging	31
4.7 Intelligence Touch Display	38
5. Common Troubleshooting	48
6. Battery Maintenance	50
6.1 Battery Storage Requirements	51
6.2 Charging Requirements After Over-discharge	51
6.3 Long-term Idle Maintenance Requirements	52
6.4 Battery Maintenance Safety Requirements	52
7. Technical Data.....	54

1 Manual Overview

1.1 Purpose

This document describes the HOME-ESS-HV-5.12K developed by Hanchu ESS in terms of its technical specifications, application scenarios as well as the guidelines for installation, commissioning, maintenance and troubleshooting. Please read this manual carefully, understand the safety information, familiarize yourself with the functions and usage of the battery, and observe the signs on the equipment and all the safety precautions in the manual.

- Please read and understand all the contents of this manual before installing and operating the product. Any damage caused by ignoring the contents of this manual may void the warranty.
- This product can only be used in accordance with the manual, local standards, laws and regulations. Any other use may cause personal injury and property damage.
- The illustrations provided in this manual are used to illustrate product concepts, including product information, installation guidelines, instructions for use, safety information, FAQs, and maintenance, etc.
- Unauthorized changes or modifications to the product are not permitted, any unauthorized changes will void the HOME-ESS-HV-5.12K warranty and Hanchu ESS will not be liable for any damages caused thereby.
- This manual and other product-related manuals are an integral part of the product and need to be kept properly for on-site installation personnel and related technical personnel to consult.

Thank you very much for choosing HOME-ESS-HV-5.12K developed by Hanchu ESS. We sincerely believe that our products can meet your needs and look forward to your feedback.



1.2 Target Audience

This manual is intended for:

- End users
- Installers
- System engineers
- Technical Support Engineers
- End users tasks described in this manual can only be done by qualified electricians.

1.3 Symbol Conventions

Table 1 Meaning of the Identity

Symbol	Description
 DANGER	"DANGER" indicates a hazard with a high level of risks which, if not avoided, could result in death or serious injuries.
 WARNING	"WARNING" indicates a hazard with a medium level of risks which, if not avoided, could result in death or serious injuries.
 ATTENTION	"ATTENTION" indicates a hazard with a low level of risks which, if not avoided, could result in minor or moderate injuries.

The 'DANGER', 'WARNING' and 'ATTENTION' items in the manual do not represent all safety precautions to be followed, but as a supplement to all safety precautions.

Hanchu ESS is not responsible for any of the following situations:

- Operation beyond the conditions specified in this manual.
- Failure to comply with the operating instructions and safety precautions in this manual.
- Installation or use in environments that do not meet relevant international, national or local standards.
- Damage to the battery, dropping, leaking, or damage to the hardware of the device due to improper operation or intentional damage.
- Disassemble and alter equipment or modify software code without authorization.
- Failure to power up the battery in time after the battery installation and connection is completed, resulting in damage to the battery by over-discharge.
- Battery operation and management parameters are set incorrectly.
- The user or a third party uses the battery outside the scenarios specified by us, including but not limited to connecting of excess loads, mixing with batteries with different rated capacities or with other batteries.
- Damage to the battery when the battery's operating environment or external power parameters do not meet the battery's normal operating environment requirements.
- Frequent over-discharge of the battery due to improper maintenance by the user, improper expansion of the battery by the user, or not fully charged for a long time.
- Failure to maintain the battery in accordance with the operating instructions: e.g. failure to check the battery terminals regularly.
- System damages caused by improper operations of a third party or customer, including those in transportation, installation, adjustment, alteration or removal of identification marks.
- The equipment damage caused by abnormal natural environment (force majeure, such as earthquake, fire, storm, flood, mudslide, etc).
- Damages caused during transportation by the customer.
- Storage conditions do not meet the requirements of the product manual, or failure to charge the battery as required during storage, resulting in loss of capacity or irreversible damage.

2 Safety Requirements

The battery system has been designed and tested in accordance with international safety requirements. However, in order to prevent personal injury and property damage and ensure long-term operation of the battery system, please do read this section carefully and observe all safety information at all times.

2.1 General Requirements

The equipment has a high voltage. Irregular operation may generate electric shock or fire which may cause death, severe personal injuries or serious property damages. Please standardize the operation:

- It is strictly prohibited to install or operate outdoor equipments and cables (including handling equipment, operating equipment and cables, plugging and unplugging signal interfaces connected to the outdoors, working at heights, outdoor installation, etc.) in severe weather such as thunderstorm, snowy weather, strong breeze.
 - Please observe the operation sequence and safety precautions in this manual and other related manuals.
 - Follow the warning signs, cautions and precautions on the equipment.
 - Follow the manual to use correct tools, and master the correct use of tools.
 - Do not install and connect cables, maintain, or replace equipments with power on.
 - Do not wash the equipment.
 - Do not open the panel of the equipment.
 - Measure the voltage before touching conductor surface or terminal to verify that there is no risk of electric shock.
- Repair the scratches that occur during equipment transportation and installation in time. It is strictly forbidden to expose the scratched parts to the outdoor environment for a long time.
 - It is forbidden to lift and transport the batteries through the battery terminals or bolts.
 - Do not alter the internal structure or installation procedure of the equipment without prior permission of the manufacturer.
- Leave the building or the equipment area and turn on the fire alarm bell or make an emergency call immediately in the case of a fire. Do not enter the building on fire in any case.

2.2 Personnel Requirements



- Personnel installing or maintaining Hanchu ESS equipment must be trained, understand all necessary safety precautions, and be able to correctly perform all operations. Personnel who will operate the equipment, including operators, trained personnel and professionals should possess local national required qualifications in special operations such as high-voltage operations and operations of special equipment.
 - Only qualified professionals or trained personnel are allowed to install, operate and maintain the equipment.
 - Only qualified professionals are allowed to remove security facilities and overhaul equipment.
 - Only professionals or authorized personnel are allowed to replace the equipment or components (including software).
 - ❖ Professionals: personnel who are trained or experienced in equipment operations and are clear of the

sources and degree of various potential hazards in equipment installation, operation and maintenance.

- ❖ Trained personnel: personnel who are technically trained, have required experience, are aware of possible hazards on themselves in certain operations and are able to take protective measures to minimize the hazards on themselves and other people.
- ❖ Operators: operation personnel who may come into contact with the equipment, except trained personnel and professionals.

2.3 Installation Environment Requirements



- This does not apply to equipment intended to be installed in restricted access areas.
- The installation and operating environment must comply with international, national and local standards for lithium batteries and with local laws and regulations.
- Install in a location out of the reach of children.
- Garage installation needs to be far away from the direction of vehicle travel, it is recommended to install the energy storage on the wall above the body bumper to avoid an accidental collision.
- When installing the battery in a basement, keep good ventilation. Do not place flammable or explosive materials around the battery. It is recommended that the battery be mounted on the wall to avoid contacting with water.
- Install the battery in a dry and well-ventilated environment. Secure the battery on a solid and flat surface.
- Install the battery in a sheltered place or install an awning over it to avoid direct sunlight or rain.
- Install the battery in a clean environment that is free from sources of strong infrared radiation, organic solvents, and corrosive gases.
- Precautions should be taken for installation in areas with frequent natural disasters such as floods, mudslides, earthquakes and typhoons.
- Keep the battery away from fire sources. Do not place any flammable or explosive materials around the battery.
- Keep the battery away from water sources such as taps, sewer pipes, and sprinklers to prevent water seepage.
- Do not install the battery in a position where it is easy to touch as the temperature of the chassis and heat sink is high when the battery is running.
- To prevent fire due to high temperature, ensure that the vents and the cooling system are not blocked when the battery is running.
- Do not expose the battery to flammable, explosive gas or smoke. Do not perform any operation on the battery in such an environment.
- Do not install the battery on a moving object, such as ship, train or car.
- Do not install the system outdoors in a salt-affected area because the system may be corroded. A salt-affected area is an area within 500m from the coast or affected by sea breeze. The area affected by the sea breeze varies according to meteorological conditions (such as typhoons and seasonal winds) or topographical conditions (such as DAMS and hills).

2.4 Electrical Requirements

➤ 2.4.1 General Requirements



Before connecting cables, ensure that the product is intact. Otherwise, electric shocks or fire may occur.

- Ensure that all electrical connections comply with local electrical standards.
- Ensure that the cables you prepared meet local regulations.
- Use dedicated insulated tools when performing high-voltage operations.

➤ 2.4.2 DC Operation



Do not connect or disconnect power cables with power-on. Transient contact between the core of the power cable and the conductor will generate electric arcs or sparks, which may cause fire or personal injury.

- Before connecting cables, cut off the power supply if people may contact energized components.
- Please ensure that the label on the power cable is correct before connecting the power cord.
- Disconnect all inputs and operate the equipment only after the equipment is powered off.

➤ 2.4.3 Cabling Requirements



When routing cables, ensure that a distance of at least 30mm exists between the cables and heat-generating components or areas. This prevents damage of the insulation layer of the cables.

When the temperature is low, violent impact or vibration may damage the plastic cable sheathing. To ensure safety, comply with the following requirements:

- ❖ Cables can be laid or installed only when the temperature is higher than 0°C. Handle cables with caution, especially at a low temperature.
- ❖ If the storage environment temperature of the cables is below 0°C, the cables must be stored at room temperature for more than 24 hours before laying the cables.

2.5 Personal Safety



Wear proper personal protective equipment during operation. If there is a probability of personal injury or equipment damage, stop the operations and take feasible protective measures immediately.

- Use tools correctly to avoid hurting people or damaging the equipment.
- The anti-static gloves must be worn when touching the equipment. Do not wear clothes that can easily generate static electricity.
- Do not touch the shell when the equipment is running, the temperature of the shell is high, which may cause burns.
- To ensure personal safety and normal use, it should be grounded reliably before use.
- When the battery is faulty, the temperature may exceed the burn threshold of the touchable surface. Therefore, avoid touching the battery.

- The electrolyte is harmful to your skin and eyes, so do not disassemble or damage the battery and avoid contact with the electrolyte.
- Do not place irrelevant objects on the top of the equipment or insert them into any position of the equipment.
- Do not place flammable objects around the equipment.
- To prevent explosions and body injuries, do not place batteries in a fire.
- Do not place the battery module in water or other liquids.
- Do not short-circuit the battery terminals or it will cause a fire.
- Do not use water to clean electrical components inside or outside of a cabinet.
- Do not stand, rely or sit on the equipment.
- Do not destroy any module of the equipment.
- Batteries may cause electric shocks and high short-circuit currents. When using the battery, pay attention to the following points:
 - a) Remove all metal objects from yourself, such as watches and rings.
 - b) Use tools with insulated handles.
 - c) Wear rubber gloves and boots.
 - d) Do not put tools or metal parts on the top of the battery.
 - e) Disconnect the charging power supply before connecting or disconnecting the battery terminal.
 - f) Determine if the battery is unexpectedly grounded. Please remove power from the ground if accidental grounding occurs.

2.6 Battery Safety



Do not expose batteries at high temperatures or around heat-generating sources, such as sunlight, fire sources, transformers and heaters. The battery may cause a fire if overheated.







- To avoid leakage, overheating or fire, do not disassemble, alter or damage batteries, do not insert foreign objects into batteries or place batteries in water or other liquids.
- The fire hazard of the lithium-ion battery energy storage system is high. Consider the following safety risks before handling batteries:
 - ❖ Battery electrolytes can be combustible, toxic and volatile.
 - ❖ Battery thermal runaway can generate flammable gas and harmful gas such as CO and HF.
 - ❖ The excessive concentration of flammable gas generated from battery thermal runaway may cause combustion and explosion.
- The batteries must be stored separately inside the packaging. Do not store batteries together with other materials or in the open air. Do not stack batteries too high.
 - Do not use batteries beyond the warranty period.
 - Do not remove the battery packaging before use. Batteries should be charged during storage by professionals as required. Put batteries back into their packaging after charging during storage.
 - Move batteries in the correct direction. Do not place a battery upside down or tilt it.
 - Protect batteries from impact.
 - Do not perform welding or grinding work around batteries to prevent fire caused by electric sparks or



arcs.

- Use batteries within the temperature range specified in this manual.
- Do not use damaged batteries (such as damages caused when a battery is dropped, bumped or dented on the enclosure). Damaged batteries may release flammable gases. Do not store damaged batteries near undamaged products.
 - Do not place damaged batteries in close proximity to flammable materials.
 - Monitor damaged batteries during storage for signs of smoke, flammable electrolyte leakage, or heat.
 - Do not move the battery system while the battery is operating. Including, but not limited to, when the circuit breaker and switch button are on, it is not allowed to move the BDU or modules, and it is also not allowed to plug and unplug the connector, otherwise there is a risk of electric shock.
 - When the battery system is necessary to move or rewire, the power must be cut off.

➤ 2.6.1 Label Description

Table 2 Label Description

Symbol	Explanation
	<p>CE marking</p> <p>The system complies with the requirements of the applicable EU directives.</p>
	<p>Observe the documents</p> <p>Observe all documents supplied with the system.</p>
	<p>Disposal !</p> <p>Do not dispose of the system together with household waste, please contact Hanchu service partner to dispose of it in accordance with regulations for electronic waste and used batteries.</p>
	<p>Grounding conductor</p> <p>This symbol indicates the position for connecting a grounding conductor.</p>
	<p>Beware of a danger zone!</p> <p>This symbol indicates that the product must be additionally grounded if additional grounding or equipotential bonding is required at the installation site.</p>
	<p>Beware of high voltage and operating current!</p> <p>The product operates at a high voltage and current. Work on the product must only be carried out by skilled and authorized personnel.</p>
	<p>Beware of hot surfaces!</p> <p>The product can get hot during operation. Avoid contact during operation.</p>

	<p style="text-align: center;">Capacitor discharge</p> <p>Danger to life due to high voltages in the inverter. Do not touch live parts for 5 minutes after disconnection from the power sources.</p>
	<p style="text-align: center;">Do not touch the product until 90 seconds after shutting down</p>
	<p style="text-align: center;">Keep ventilated</p>

2.7 Emergency Measures



➤ 2.7.1 Damaged Battery

- If the battery is damaged or flooded, it may leak the electrolyte and cause a short circuit fire.
- If the battery is wet or immersed in the water, do not try to touch it.
- If the battery seems to be damaged, they are not suitable for use and may be dangerous to persons or property.
 - Avoid touching the leaked liquids or gases in the case of battery leakage or abnormal odor; do not approach the battery and contact professionals immediately. Professionals must wear safety goggles, rubber gloves, gas masks, and protective clothing.
 - Electrolyte is corrosive and can cause irritation and chemical burns. In case of direct contact with the battery electrolyte, do as follows:
 - ❖ Inhalation: Evacuate contaminated areas, get fresh air immediately and seek immediate medical attention.
 - ❖ Eye contact: Immediately flush your eyes with water for at least 15 minutes, do not rub your eyes and seek medical attention immediately.
 - ❖ Skin contact: Wash the affected areas immediately with soap and water and seek medical attention immediately.
 - ❖ Ingestion: Seek immediate medical assistance.

➤ 2.7.2 Battery Drop Emergency Measures

- If a battery is dropped or violently impacted during installation, internal damage may occur. Do not use such batteries. Otherwise, safety risks such as cell leakage and electric shock may arise.
- If a dropped battery has obvious damage or abnormal odor, smoke or fire occurs, evacuate the personnel immediately, call emergency services, and contact professionals. Professionals can use fire extinguishing facilities to extinguish the fire under safety protection.

- If a dropped battery has no obvious deformation or damage and no abnormal odor, smoke or fire occurs, contact professionals to transfer the battery to an open and safe place or contact a recycling company for disposal.

➤ **2.7.3 Fire Emergency Measures**

- If a fire occurs, power off the system if it is safe to do so.
- Use carbon dioxide, FM-200 or ABC dry powder extinguishers to extinguish the fire.
- Ask firefighters to avoid contacting with high-voltage components during extinguishing fires to prevent the risk of electric shock.
 - Overheating may cause batteries to deform and leak corrosive electrolyte or toxic gas. Keep away from the batteries to avoid skin irritation and chemical burns.

2.8 Battery Recovery Process



- Dispose of used batteries in accordance with local laws and regulations. Do not dispose of batteries as household waste.
- If the batteries leak or are damaged, contact technical support or a battery recycling company for disposal.
- If the batteries are out of service life, contact a battery recycling company for disposal.
- Do not expose batteries to high temperatures or direct sunlight.
- Do not expose batteries to high humidity or corrosive environments.

2.9 EU Declaration of Conformity



The batteries sold on the European market by Hanchu Ess comply with the requirements of the following directives:

- Electromagnetic compatibility Directive 2014/30/EU (EMC)
- Electrical Apparatus Low Voltage Directive 2014/35/EU (LVD)
- Battery Directive 2006/66/EC and Amending Directive 2013/56/EU
- Waste Electrical and Electronic Equipment 2012/19/EU

3 Product Description

The HOME-ESS-HV-5.12K is a new generation equipment with home energy storage system that can meet the diverse needs of global users. High-performance lithium iron phosphate battery is used for functional integration and modular structure design. It has realized the convenient expansion, rapid product installation, load matching, remote control and many other functions.

Note : The Max charge/discharge current of the HOME-ESS-HV-5.12K product is 100 A. Please do not operate it under conditions exceeding this current. If the input or output current of the inverter connected to the battery exceeds 100 A, please use it in conjunction with the Hanchu combiner box.

3.1 Product Description

➤ 3.1.1 System Composition

The battery system, which consists of a Battery Energy Distribution Unit (BDU for short), battery modules and a base, can store and release the electric energy according to the requirements of the solar energy storage system.

The Battery Energy Distribution Unit

The Battery Energy Distribution Unit, HOME-ESS-HV-5.12K-BDU, is connected to the total positive and negative electrodes of the battery module, and inside the BDU, there are communication firmware, Hall relays, resistors, and other parts to form a control circuit that is then connected to the power grid.

The battery modules

Battery module, HOME-ESS-HV-5.12K, consists of high-performance lithium iron phosphate battery, fireproof module, aluminum extrusion end plate and other components, which is safe and reliable, and at the same time can be charged and discharged according to the load.

➤ 3.1.2 Model Identification Description

- The model of a battery system is HOME-ESS-HV-15.36~61.44K.

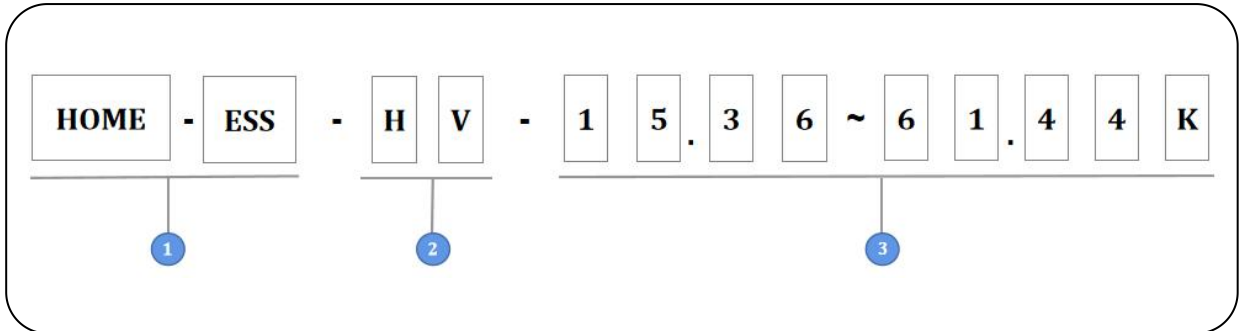

Figure 1 Name of the Battery System

Table 3 Definition of the Battery System

No.	Meaning	Value
1	Product identification	HOME-ESS: Home energy storage
2	Voltage level	HV: High Voltage
3	Battery system capacity	15.36~61.44K: The battery system capacity is 15.36~61.44kW·h

- The model of a BDU is HOME-ESS-HV-5.12K-BDU.

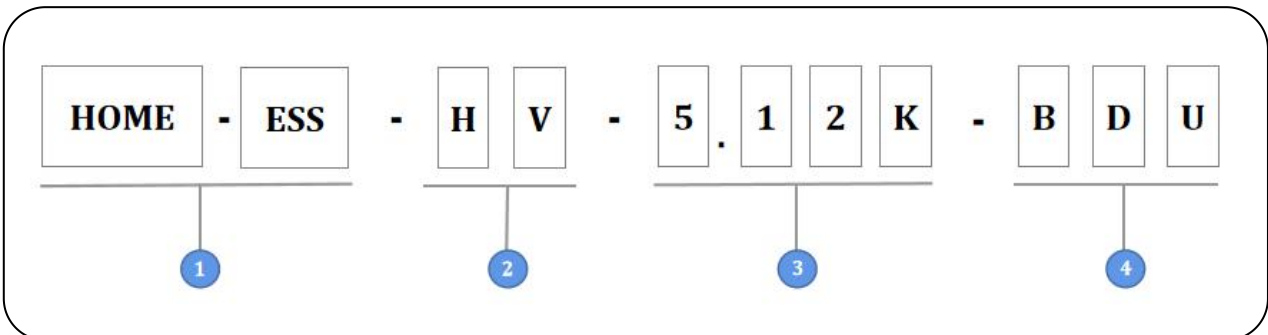

Figure 2 Name of the BDU

Table 4 Definition of the BDU

No.	Meaning	Value
1	Product identification	HOME-ESS: Home energy storage
2	Voltage level	HV: High Voltage
3	Battery module capacity	5.12K: The battery module capacity is 5.12KW·h
4	Battery system parts	BDU: Battery energy Distribution Unit of the battery system

- The model of a battery module is HOME-ESS-HV-5.12K.

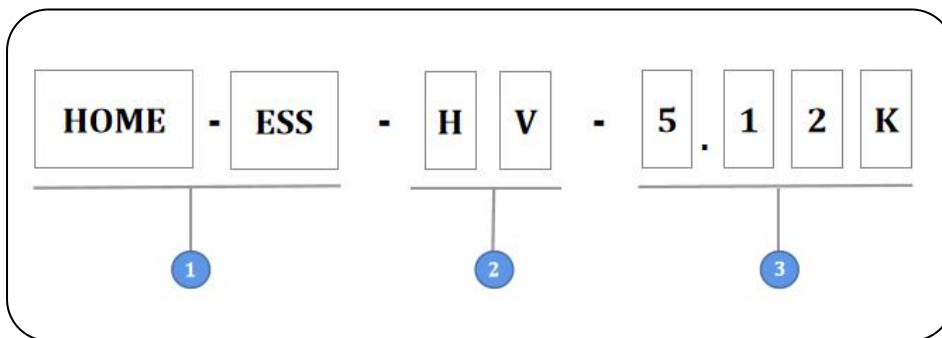

Figure 3 Name of Battery Modules

Table 5 Definition of Battery Modules

No.	Meaning	Value
1	Product identification	HOME-ESS: Home energy storage
2	Voltage level	HV: High Voltage
3	Battery module capacity	5.12K: The battery module capacity is 5.12kW·h

➤ 3.1.3 Usable Energy Description

- Per battery system

The battery system supports capacity expansion. Per battery system can support capacity adjustment for a minimum of 3 and a maximum of 12 battery modules.

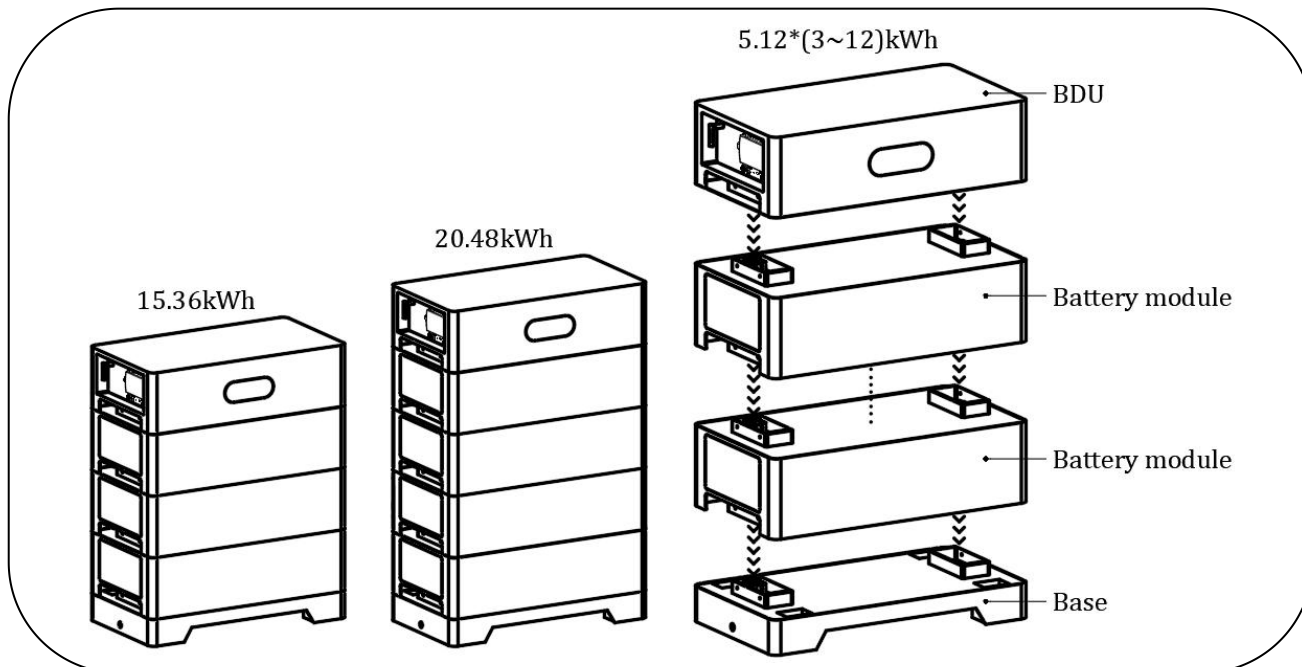

Figure 4 Diagram of the Battery System

- Parallel cluster battery system

An energy storage system can support up to 4 battery systems in parallel.

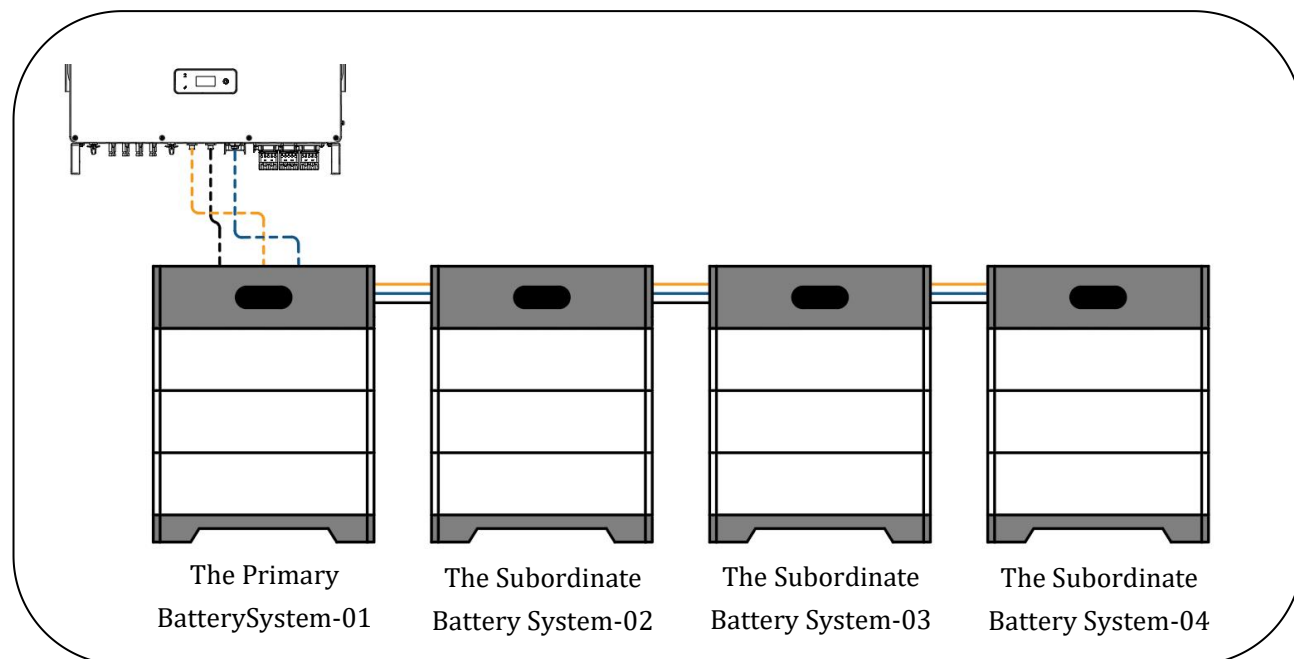

Figure 5 Diagram of Energy Storage System

3.1.4 Product Dimension And Weight

This manual will show you the installation and electrical connection of 4 battery modules.

Table 6 Product Dimension And Weight

	Width	Depth	Height	Weight
BDU	650mm	355mm	183mm	15kg
Battery module	650mm	355mm	183mm	43kg
Base	650mm	355mm	80mm	4kg

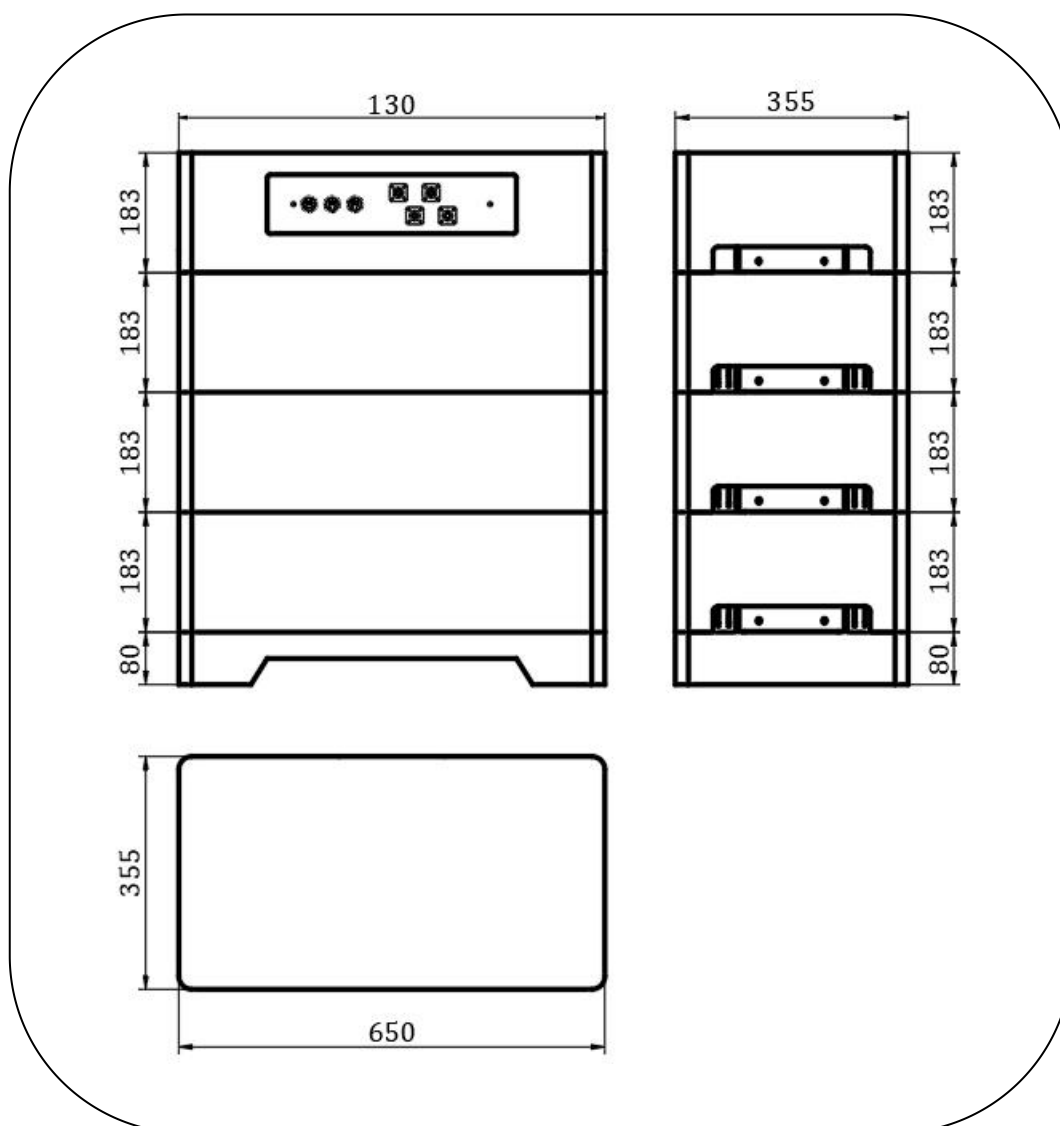

Figure 6 Picture of the Product

3.2 Interface Description

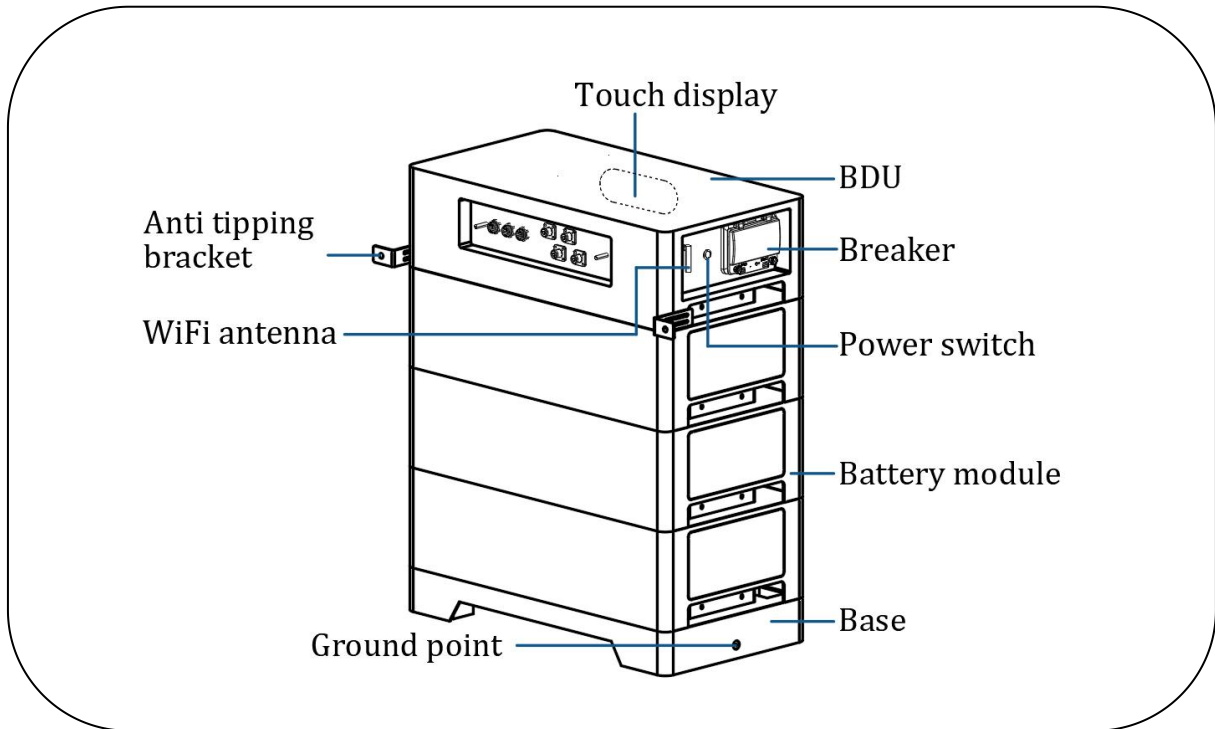

Figure 7 Battery Interface Description

3.3 Product Parameters

Table 7 Battery Module Parameters

No.	Project	Parameter	Remark
1	Models	HOME-ESS-HV-5.12K	
2	Type	LFP(LiFePO4)	
3	Dimensions (mm) W*D*H	650*355*183	
4	Enclosure protection rating	IP65	
5	Nominal voltage (V)	51.2	
6	Operating voltage range (V)	48~57.6	
7	Nominal Energy (Wh)	5120	
8	Nominal discharge current (A)	50	
9	Max. discharge current (A)	100	
10	Nominal charge current (A)	50	
11	Max. charge current (A)	100	
12	Charging temperature (°C)	-5~55	
13	Discharging temperature (°C)	-20~60	
14	Environment temperature (°C)	Charge: 0~40 Discharge: -10~40	
15	Total weight (kg)	43	
16	Battery Designation	IFpP51/161/119[16S]M/- 20+40/95	

Table 8 Battery System Parameters

No.	Project	Parameter	Remark
1	Models	HOME-ESS-HV-15.36~61.44K	
2	Type	Rechargeable Lithium iron phosphat battery	
3	Dimensions (mm) W*D*H	BDU: 650*355*183 Battery module: 650*355*183 Base: 650*355*80	
4	Enclosure protection rating	IP65	
5	Module configuration	4 parallel 12 strings	4P12S
6	Nominal voltage (V)	153.6~614.4	
7	Operating voltage range (V)	144~691.2	
8	Nominal Energy (kWh)	15.36~61.44	
9	Nominal discharge current (A)	50	
10	Max. discharge current (A)	100	
11	Nominal charge current (A)	50	
12	Max. charge current (A)	100	
13	Charging temperature (°C)	0~50	
14	Discharging temperature (°C)	-10~60	
15	Environment temperature (°C)	Charge: 0~40 Discharge: -10~40	
16	Total weight (kg)	BDU: 15 Battery module: 43 Base: 4	
17	Battery Designation	IFpP51/161/119[48~192S]M/-20+40/95	
18	Communication interface	CAN/RS485/WIFI/Bluetooth	
19	Maximum parallel number	4	

4 Installation

4.1 Installation Note

Please read and understand this section carefully before installing the product!

➤ 4.1.1 Personnel Qualification

Product installers should have received safety technical training, obtained the local electrician certifications and the authorized qualifications for product installation. And installers should be familiar with electrical equipment, accumulate relevant experience and have the following capabilities, including but not limited to:

- Setup, startup, shutdown, grounding, short-circuiting and repair of electrical equipment.
- Standardized maintenance and use of protective tools for electrical equipment.
- Providing emergency assistance for the injured.
- Complying with local laws, regulations, standards and directives.

➤ 4.1.2 Installation Environment

Please make sure the installation location meets the following conditions :

- The building is designed to withstand earthquakes.
- The floor is flat and hard, and the area has minimal dust and dirt.
- The ambient environment is cool, dry, well-ventilated, and away from the sea, salt water, humid air, heat sources as well as direct sunlight.
- Temperature and humidity are kept at a constant level.
- There are no flammable and explosive items, corrosive gases, including ammonia and acid vapors, and contaminants.

Note: If the ambient temperature exceeds the operating range, the battery system will stop working to protect itself. The optimal temperature range for battery operation is 15°C to 35°C. Frequent exposure to inappropriate temperature may reduce battery performance and life.

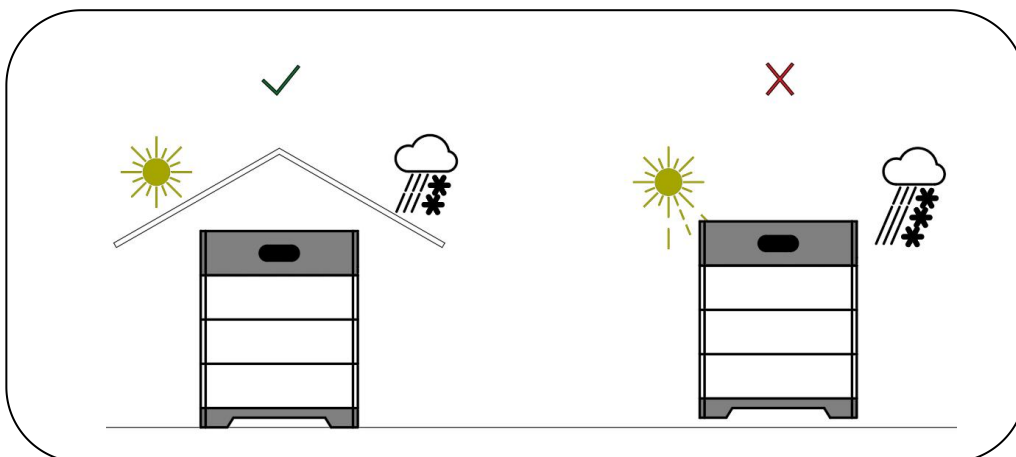

Figure 8 Sample of Installation Environment

➤4.1.3 Installation Direction

The battery system can be installed on the ground. Don't install the battery system at inclined, horizontal, or upside down positions.

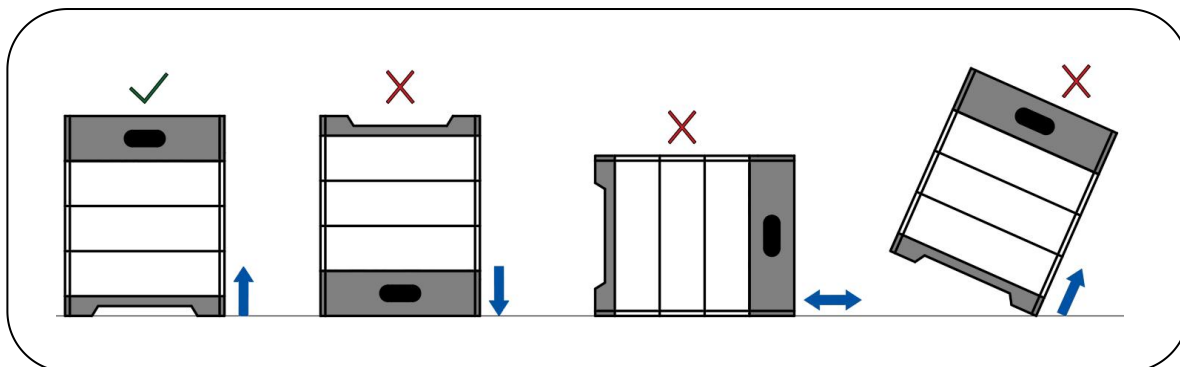

Figure 9 Sample of Installation Direction

➤4.1.4 Installation Space

Leave enough space to install the battery system. Installation space as shown below.

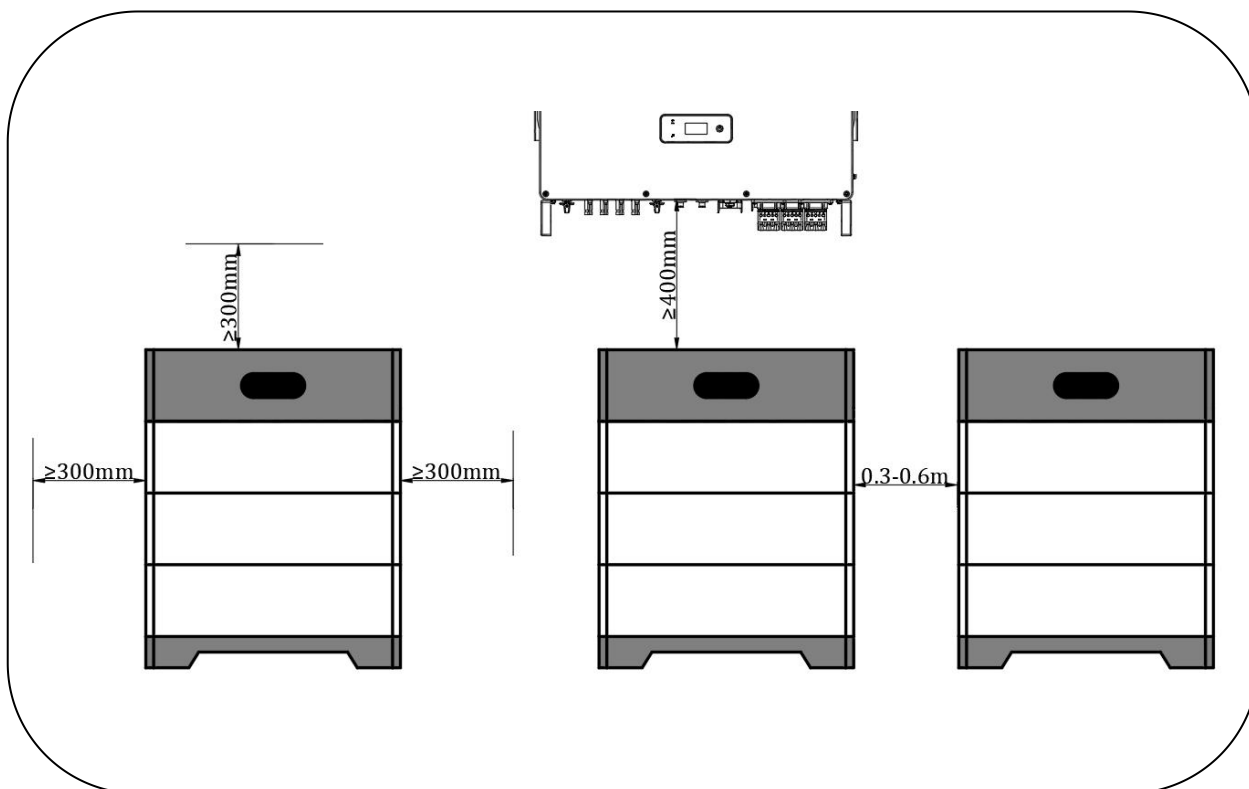

Figure 10 Installation Space diagram

4.2 Installation Preparation

➤4.2.1 Personal Protective Equipment

The product is a household energy storage system. Improper operation may cause personal injury and property damage.

Personal protective tools must be used during installation.

The following are the recommended personal protective tools:

- Safety gloves: Prevent the risk of electric shock and scratches during installation.
- Safety glasses: Prevent eye damage from splashing foreign objects during installation.
- Safety Shoes: Prevent the risk of electric shock. Ensure safety in case the module is accidentally dropped during installation.



Figure 11 Personal Protective Equipment

➤4.2.2 Installation Tools

Tools needed in the process of installing equipment, more effective to improve installation efficiency.

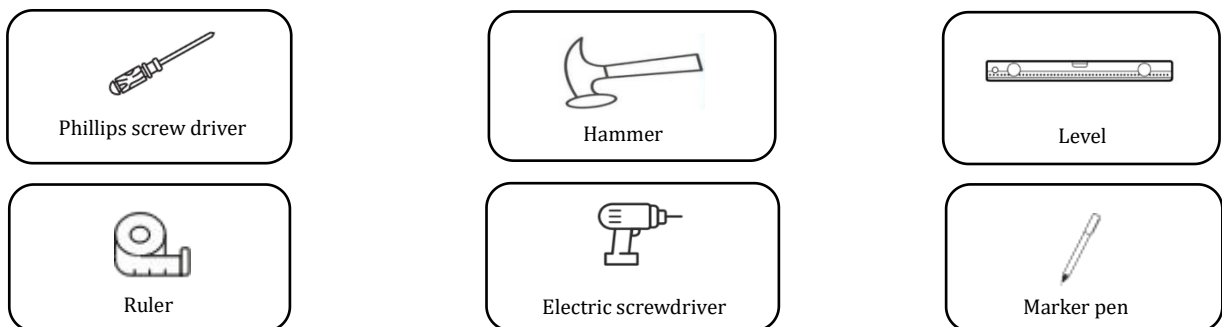

Figure 12 Installation Tools

➤4.2.3 Open Box to Check

- Make sure the battery is intact during shipping. If there is any visible damage such as cracks, please contact your dealer immediately.
- Tear off the packaging tapes to unpack the battery. Ensure that the battery packaging and all related items are in good condition.
- Please check the packing list carefully by referring to Section 4.2.4 product accessories. If there's any item missing, please contact your dealer directly.

➤4.2.4 Product Accessories

Table 9 Product Accessories of BDU

Label	Name	Quantity	Function description
A	BDU	1	Control the operation of the battery system
B	Base	1	Support battery system
C	Back panel	1	Back Shelter Panel
D	Power cable A1/A2 Quick plug terminal at both ends/black	1	Connect the negative pole between the battery system and the inverter
E	Power cable B1/B2 Quick plug terminal at both ends/red	1	Connect the positive pole between the battery system and the inverter
F	Power cable 3(Optional) Quick plug terminal at both ends/black	1	Connect the negative pole between the battery systems
G	Power cable 4(Optional) Quick plug terminal at both ends/red	1	Connect the positive pole between the battery systems
H	CAN communication cable 1	1	Connect the communication interface between battery system and inverter
I	CAN communication cable 2 (Optional)	1	Connect the communication interface between battery systems
J	Anti tipping bracket	2	Fix battery
K	Expansion tube/screw Diameter 6mm, depth 50mm	7	Fixed bracket
L	Screw/M4*10	12	Connected to ground terminal/Fix bracket/Fix BDU and modules
M	Terminal/OT6-4	1	Connected to ground wire
N	Quick Installation Guide	1	Product installation guide
O	L-shaped hexagonal tool/3mm- 128*25	1	Tools for tightening screws

Table 10 Product Accessories of Battery Modules

Label	Name	Quantity	Function description
A	Battery module	1	System core components
B	Screw/M4*10	5	Fix battery modules

4.3 Installation

- Make sure the ground is level and strong enough to bear the weight of products.
- Before you start connecting cables, make sure that the inverter and battery are entirely switched off!
- Make sure there is no water source above or near the battery, including downspouts, sprinklers, or faucets.
- The altitude to install the equipment shall be lower than the maximum working altitude 2000m.
- Install the equipment away from electromagnetic interference. If there is any radio or wireless communication device below 30MHz near the equipment, make sure that the equipment is at least 30m far away from the wireless device.

Step 1: Locate drill holes on the floor

Place the base along the wall and the base distance from the wall is 25-48mm. There are positioning holes on all sides of the base. Locating drill holes on the floor using the base as a template, mark the positions of the 4 holes, and then drill 10mm holes to ensure that the depth of the holes exceeds 50mm.

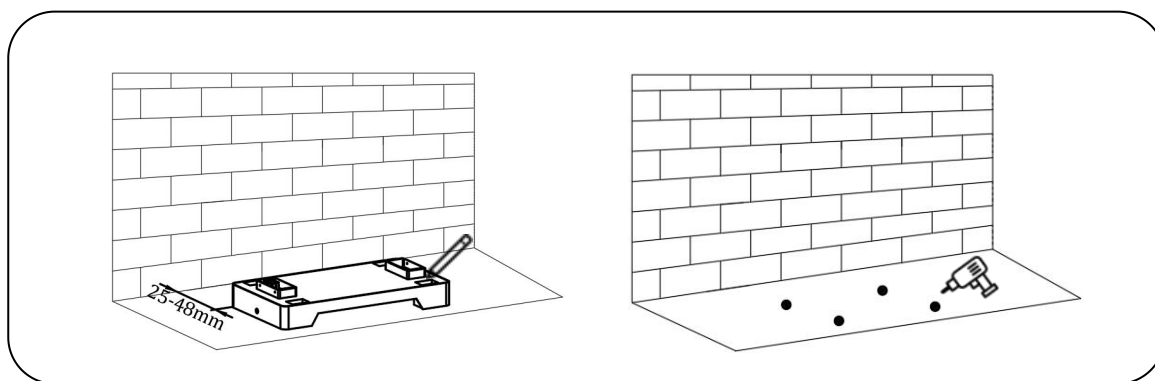

Figure 13 Sample of Step 1

Step 2: Fix the base

Fit the expansion tubes into the holes, pull them tight, and then use the expansion screws (packaged with expansion tube for use) to install and secure the base to the floor. Note the left and right orientation of the base.

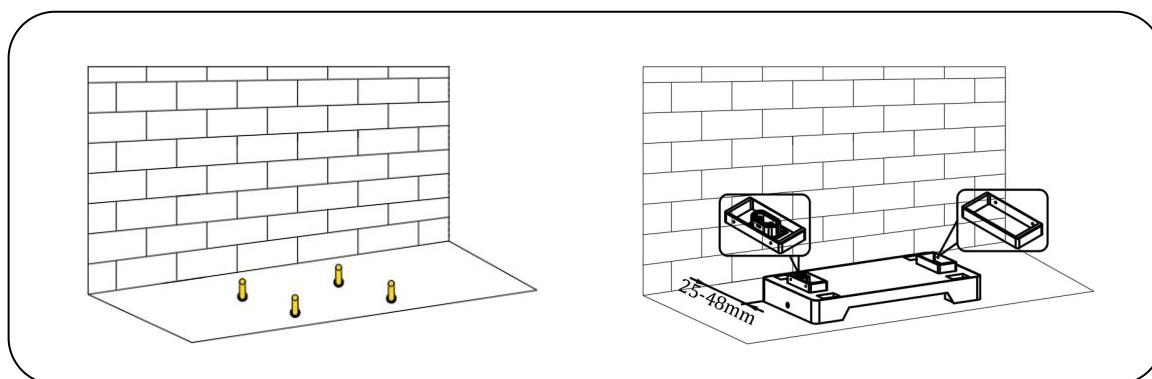

Figure 14 Sample of Step 2

Step 3: Install the battery

Install the module and BDU in order from bottom to top. Observed from both sides of the battery system, make sure that the locking holes on both sides of the battery system overlap, if not, you need to re-adjust the position of the battery to make it overlap.

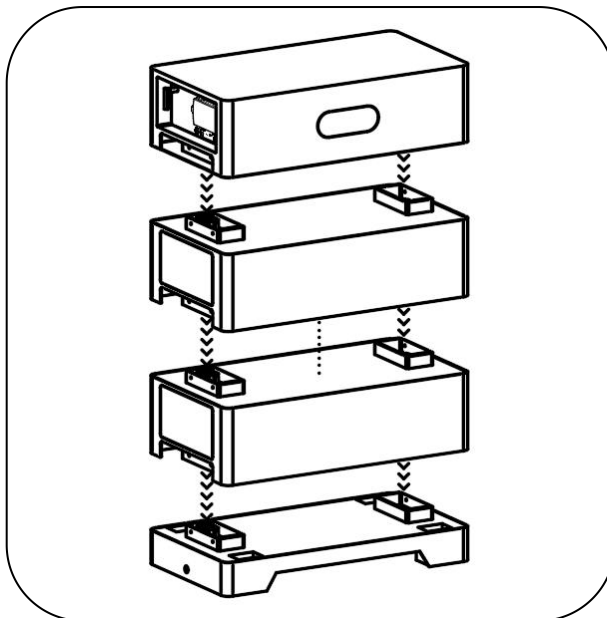

Figure 15 Sample of Step 3

Step 4: Install the anti tipping bracket

There are threaded holes on the left and right sides of the BDU. Using the M4x12 screws to install the anti tipping bracket to it. During installation, take care to adjust the position of the anti-tipping bracket.

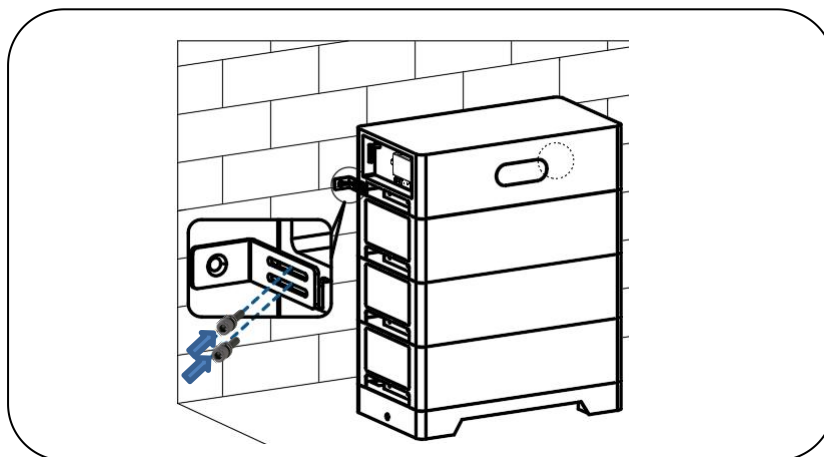

Figure 16 Sample of Step 4

Step 5: Locate drill holes on the wall

Using the anti-tipping brackets as a template, use a marker pen to locate on the wall, then drill holes and install expansion screws. Before locking anti tipping bracket, complete power cable connection and communication connection. Note that you need to take down the BDU and a module when drilling and give the battery system a good protection to prevent foreign objects from entering and damaging the equipment.

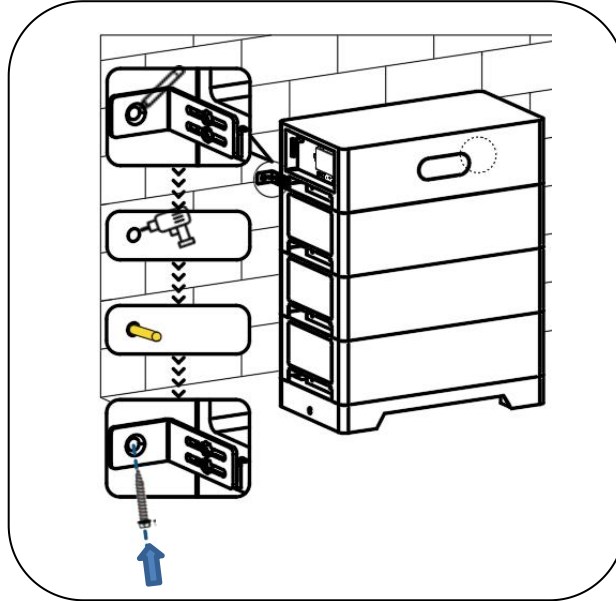

Figure 17 Sample of Step 5

Step 6: Fix the battery modules

There are screw holes on the left and right sides of the battery system. Using the M4x12 screws to lock the BDU, modules and base. The distance between the battery and the inverter should be about 400mm.

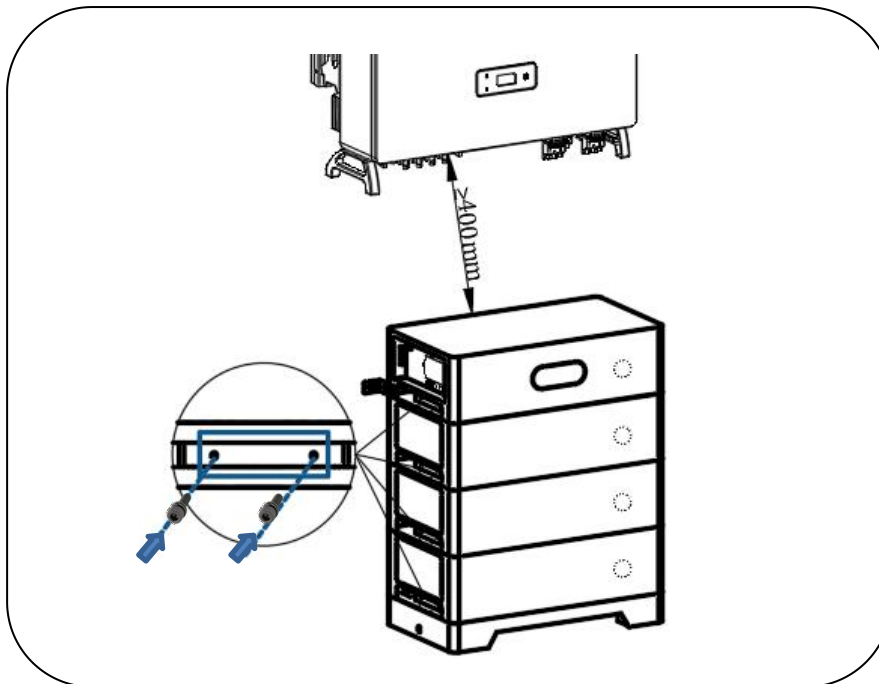

Figure 18 Sample of Step 6

Note:

- 1) Install the battery system in the order of base, module, BDU, pay attention to the up and down direction, please do not reverse.
- 2) High voltage products of different models cannot be mixed and stacked. High-voltage stacked modules must be of the same module with the same cell capacity and SOC.
- 3) With the exception of new battery modules that can be stacked directly for the first time, all other used batteries must be discharged to cutoff voltage or fully charged and meet capacity requirements before stacking.
- 4) When connecting battery systems in parallel, ensure that the usable energy of each battery system is the same.

4.4 Electrical Connections

➤4.4.1 Overview of the Connection Area

The connection interface on the BDU is shown in the figure 19.

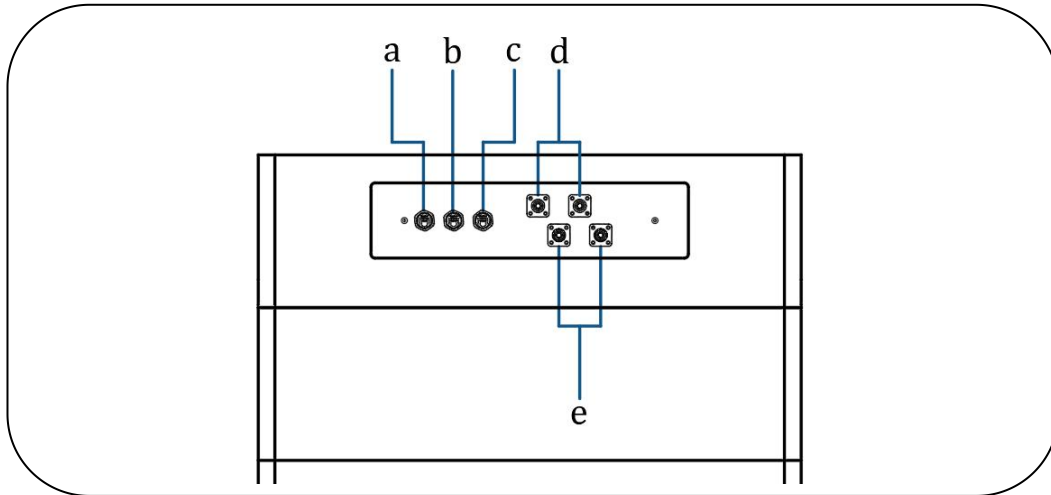

Figure 19 Connection Port Schematic

Table 11 Definition of Figure 19 Alphanumeric Code

Alphanumeric code	Silkscreen marking	Definition
a	BAT-OUT	Parallel communication port
b	BAT-IN	Parallel communication port
c	PCS	Inverter communication port
d	+	DC positive output port
e	-	DC negative output port

The communication port pins are defined as follows:

Table 12 Definition of Communication Port Pins

PIN#	2	4	5	1、3、6、7、8
PCS	GND	CAN4H	CAN4L	NC
BAT-IN	GND	CAN2H	CAN2L	NC
BAT-OUT	GND	CAN2H	CAN2L	NC

Note:

- 1) Do not connect BAT-IN to BAT-IN, as this will cause the system to malfunction!
- 2) Do not use the universal communication cable when the system is parallel, otherwise it will lead to communication abnormality, please use the dedicated communication cable.
- 3) Before connecting the cables, use a multimeter to measure cable continuity, short circuits, and verify positive and negative terminals and cable labelling.

➤4.4.2 Preparing Cables

Table 13 Cables Type

No.	Name	Function description	Size	Source
1	Ground cable	Ground the battery with a ground wire	6 mm ²	Prepared by the customer
2	Power cable A1/A2	Connect the negative pole between the battery system and the inverter	Black	Delivered with the product
3	Power cable B1/B2	Connect the positive pole between the battery system and the inverter	Red	Delivered with the product
4	Power cable 3	Connect the negative pole between the battery systems	Black	Delivered with the product(Optional)
5	Power cable 4	Connect the positive pole between the battery systems	Red	Delivered with the product(Optional)
6	CAN communication cable 1	Connect the communication interface between battery system and inverter	Black	Delivered with the product
7	CAN communication cable 2	Connect the communication interface between battery systems	Black	Delivered with the product(Optional)

➤4.4.3 System General Wiring Diagram

The electrical connections of a single battery system are shown in Figure 20.

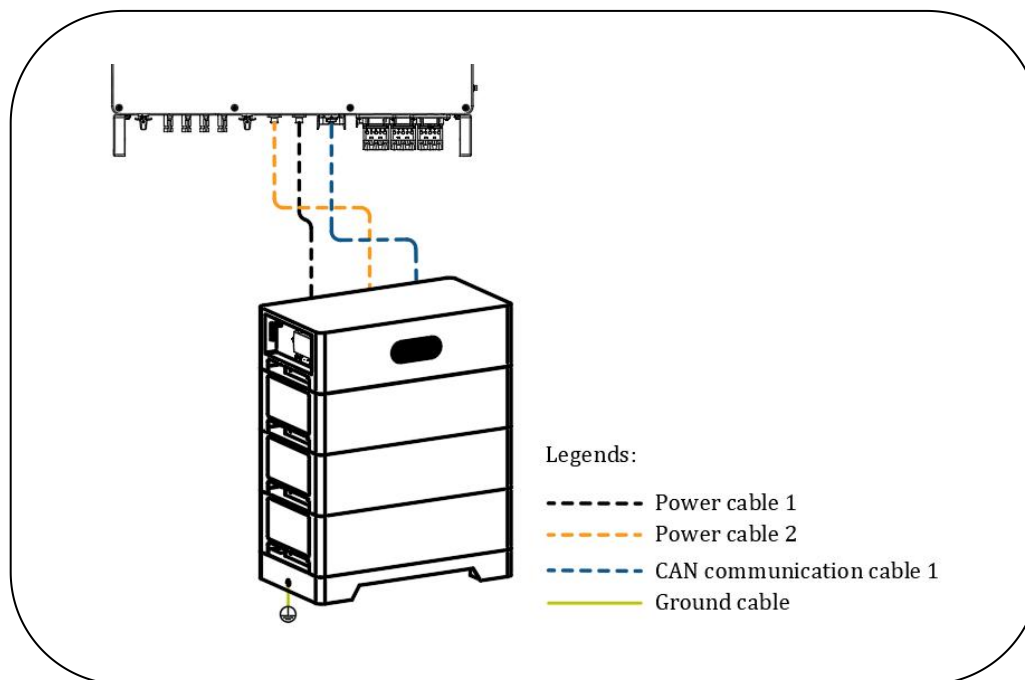

Figure 20 System General Wiring Diagram of a Single Battery System

The electrical connections of the parallel battery system are shown in Figure 21.

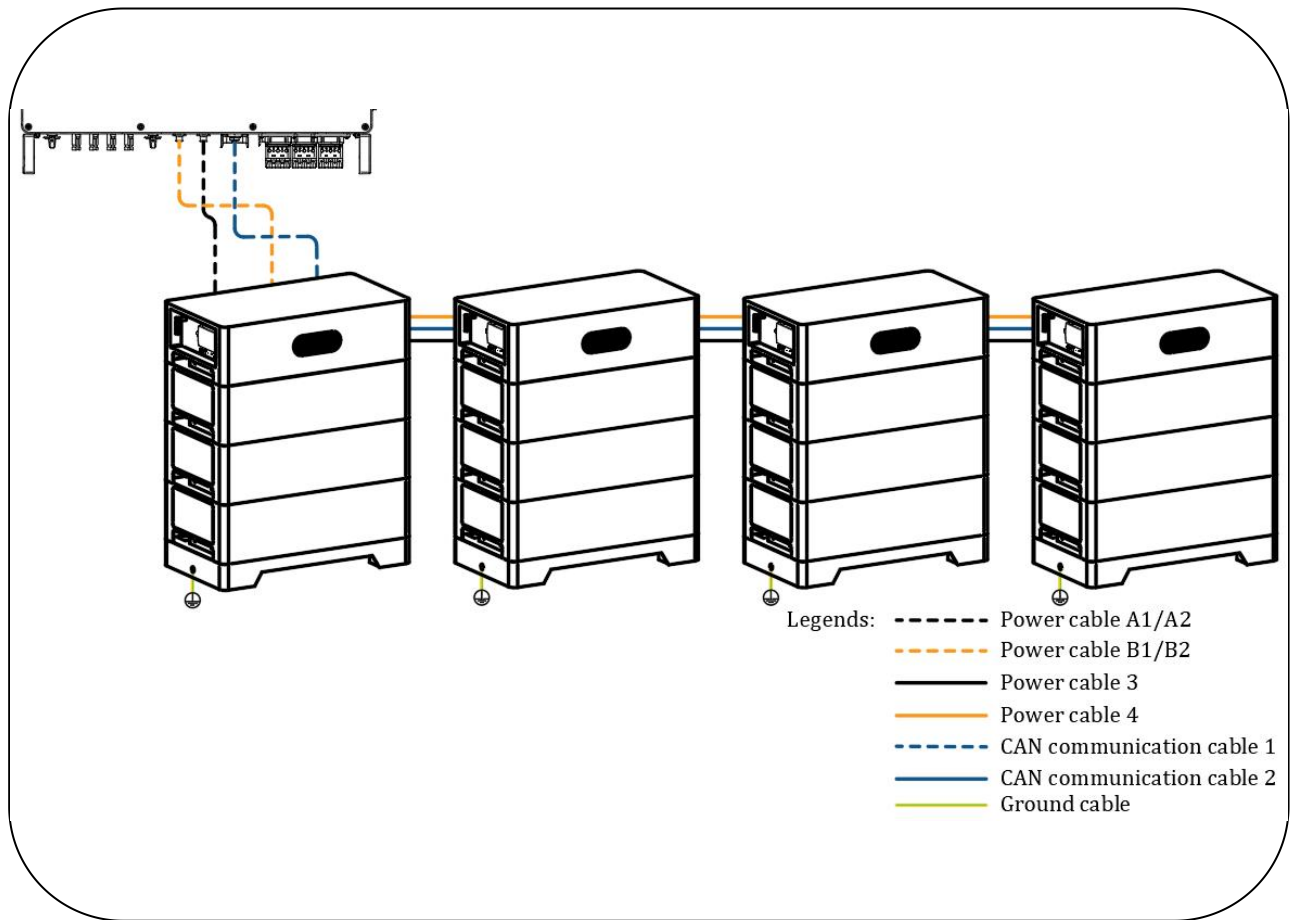

Figure 21 System General Wiring Diagram of the Parallel Battery System

➤4.4.4 Battery Ground Connection

1) Crimp the ground terminal

The customer should prepare a ground cable with a cross-sectional area of at least 6mm², then uses a ground screw and terminal to connect the ground cable. The bolt locking torque is 2NM.

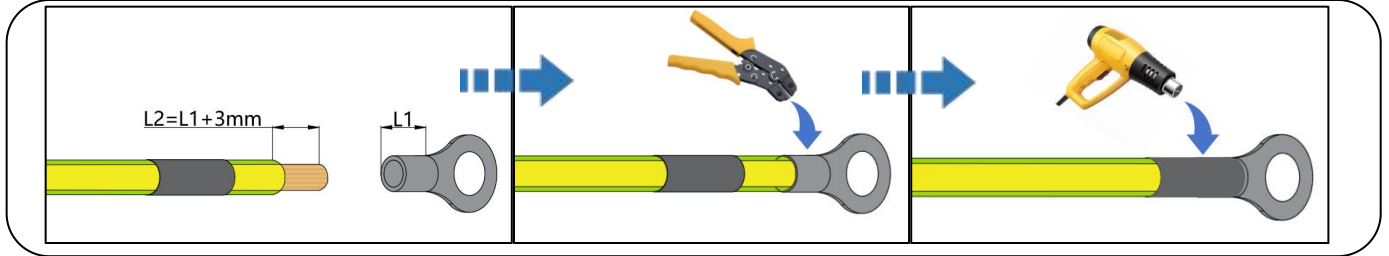

Figure 22 Sample of crimping method

2) Ground the battery with a ground wire through the ground screw and terminal.

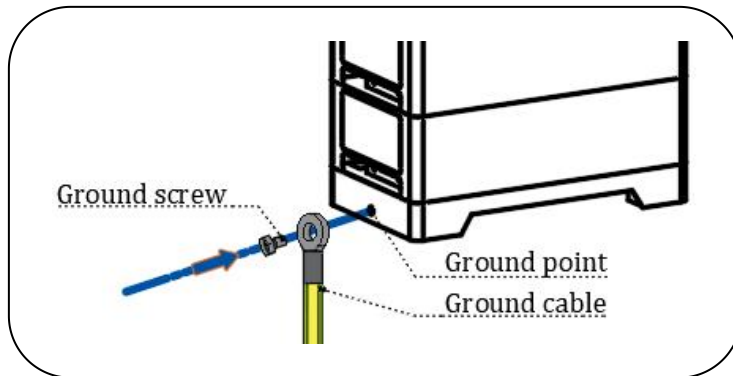

Figure 23 Sample of Battery Ground Connection

➤4.4.5 Power Connections Between Battery Systems

Use power cable 3 to connect the negative pole (P- terminal) of battery system A to the negative pole (P- terminal) of battery system B, and use power cable 4 to connect the positive pole (P+ terminal) of battery system A to the positive pole (P+ terminal) of battery system B.

For more than two battery system connections, connect the negative poles (P- terminal) between the battery systems and connect the positive poles (P+ terminal) between the battery systems.

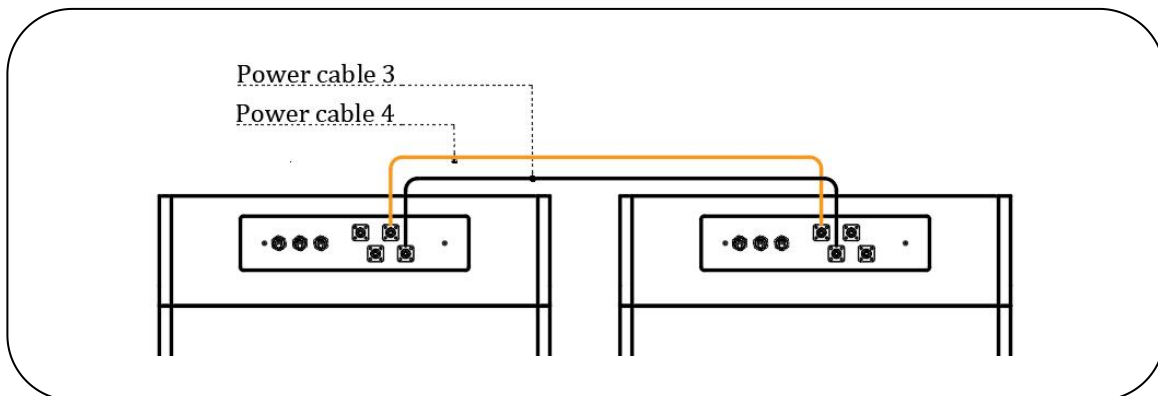

Figure 24 Sample of Power Connections Between Battery Systems

➤4.4.6 Power Connections the Primary Battery System With the Inverter

After the battery system is connected, connect the negative pole (P- terminal) of the battery system A and the BAT - terminal of the inverter with the power cable A1/A2; connect the positive pole (P+ terminal) of the battery system A and the BAT + terminal of the inverter with the power cable B1/B2.

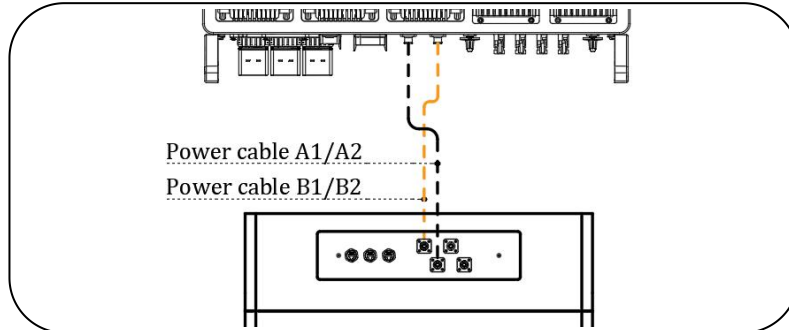

Figure 25 Sample of Power Cable Connection Between the Battery System And Inverter

Note : Before the inverter is connected to power cable, the inverter and battery systems need to be powered off. It is forbidden to mix batteries of different brands, specifications and batches, otherwise it will cause system failure.

4.5 Communication Connection

➤4.5.1 Connect the CAN Communication Cable 1

Use the CAN communication cable 1 to connect the inverter with the primary through CAN protocol.

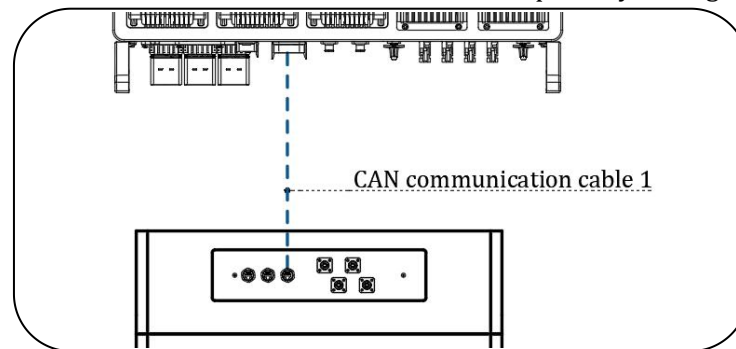

Figure 26 Sample of Connecting the CAN Communication Cable 1

➤4.5.2 Connect the CAN Communication Cable 2

Use the CAN communication cable 2 to connect the battery system in sequence through the CAN protocol.

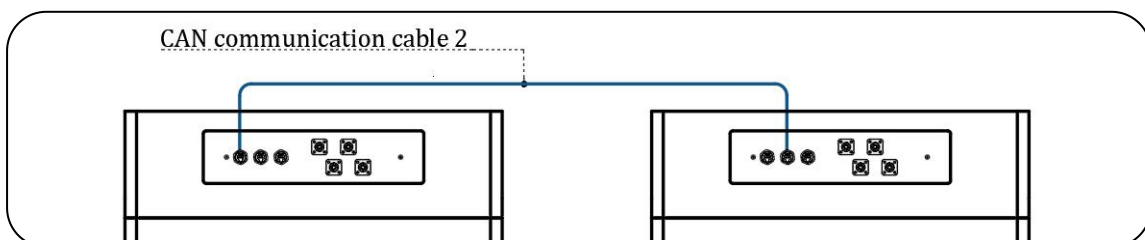

Figure 27 Sample of Connecting the CAN Communication Cable 2

Note: The communication between the inverter and the battery system must be made with CAN communication lines connected to the PCS port of the BDU, otherwise communication cannot be performed; the communication between the battery systems must be made with CAN communication lines connected to the BAT-IN and BAT-OUT port.

➤ 4.5.3 Install the Back Panel

After completing the electrical connections, use screws to lock the back panel to the BDU. And then place the BDU back on the battery system, lock anti tipping bracket, and the screws on both sides of the battery system.

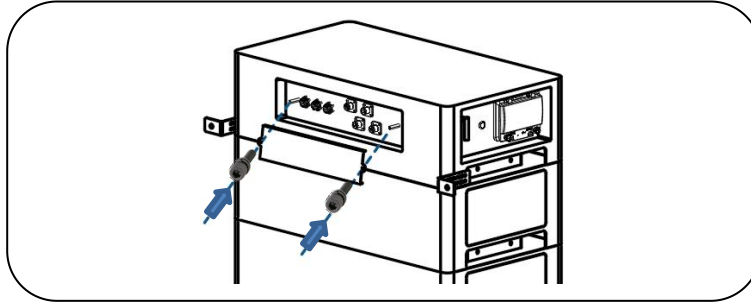

Figure 28 Install the Back Panel

4.6 Equipment Debugging

➤ 4.6.1 Equipment Power On

After confirming that the cables are connected in the correct order and the connections are tight, the system is powered on and activate the system the following order:

- 1) Toggle the circuit breaker on the primary battery pack BDU to ON as shown in Fig. 29.



Figure 29 Open the Circuit Breaker on BDU

Note: The battery system connected to the inverter is the primary battery system and the remaining parallel battery systems are subordinate battery systems 1, 2 and 3.

- Observe the icon at the bottom right of the display, the battery system is in “Standby”^①, and ensure that the battery system is “Normal”^②, as shown in Figure 30.

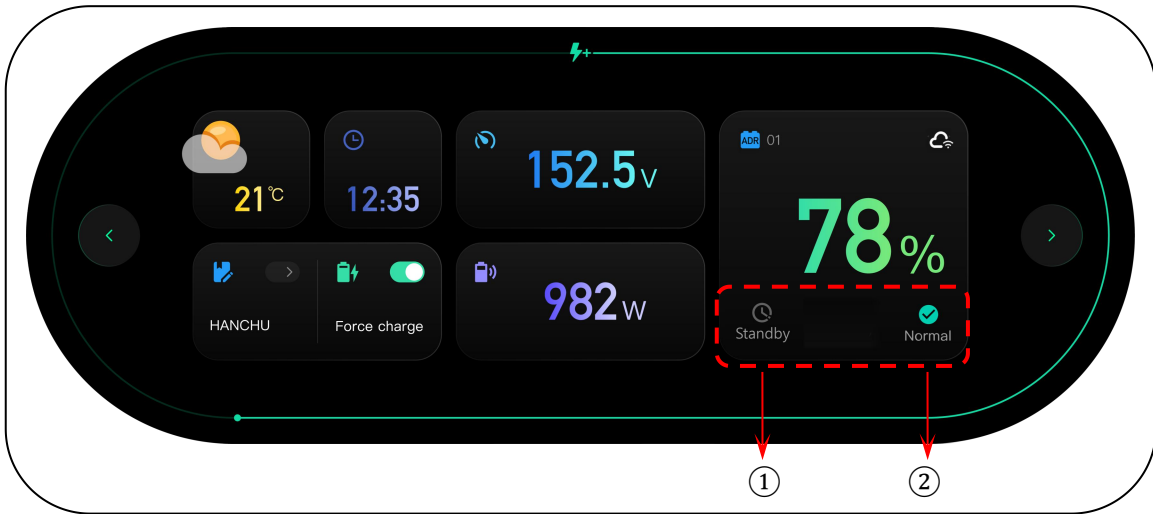

Figure 30 Normal State Of the Battery System

- If the display indicates a “Alarm”^① or a “Fault”^② as shown in Fig. 31, you need to remove the fault and then power on.

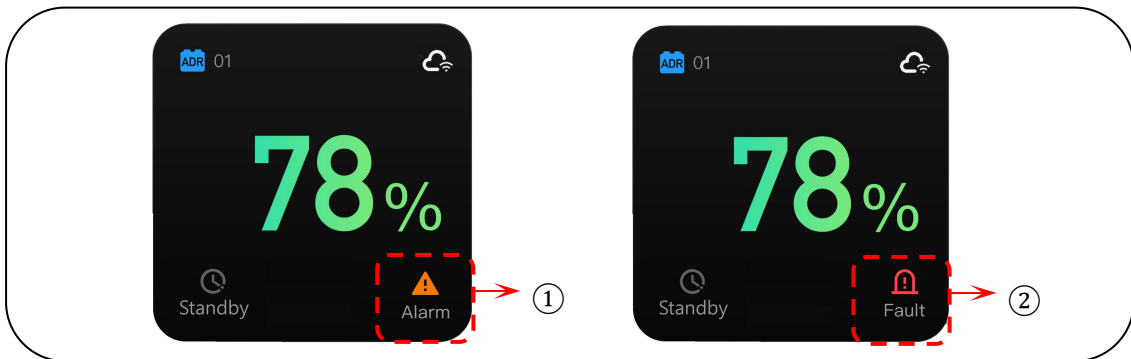

Figure 31 Alarm State Of the Battery System

- 2) Then toggle the circuit breakers on the subordinate battery systems BDUs to ON in sequence and observe the status on the display to ensure that the subordinate battery systems are normal.
- 3) After the above steps are confirmed to be correct and there are no alarm messages, press the power switch for each battery system in sequence.



Figure 32 The Power Switch Of Battery Systems

4) After the display shows successful networking,, the battery system is at “Power on” and the battery system is in “Idle” after completion.For details on the battery system connection to the network, please refer to Step 3 of 4.6.3.

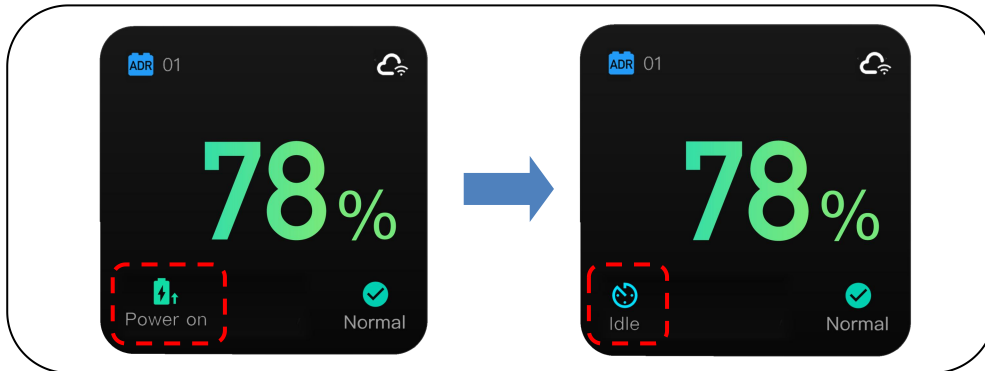

Figure 33

Note: When the system starts, ensure the boot sequence of each equipment, otherwise it may cause pre-charging and the circuit breaker protection fault.

➤ 4.6.2 Address Setting

- The system automatically address allocation for 01, 02, 03 and 04. The primary battery address bit is automatically recognised as “01”. You need to confirm that the address bit is not repeated and ensure that the battery system is normal.

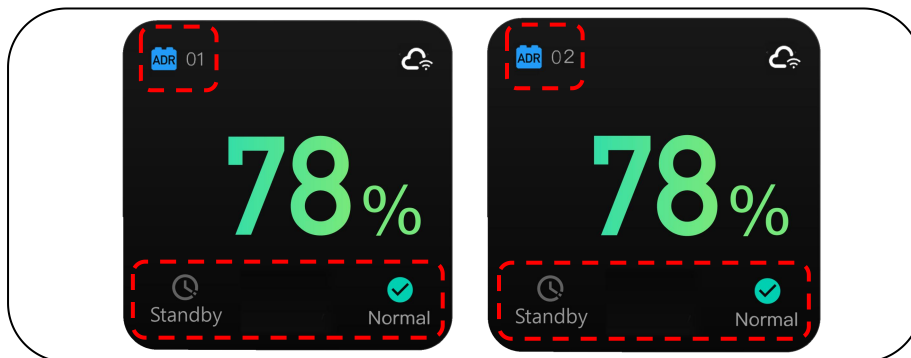

Figure 34

Note:

- 1) After the batteries are activated by pressing the switch in sequence, the system will automatically identify the primary battery system and subordinate battery systems and actively assign the address of each device in the system. If only the circuit breaker is toggled to ON but the button is not pressed, the system will not perform automatic address allocation.
- 2) The default address for a single cluster battery system is 01.

➤ 4.6.3 Inverter Protocol Selection

The battery system default factory CAN communication is Hanchu ESS protocol.

Protocol Selection:

- 1) Check which protocols the inverter supports.
- 2) If the inverter supports the battery factory default protocol, select the corresponding protocol directly on the inverter.
- 3) If the inverter supports protocols other than the battery factory default protocol, select the same protocol on the battery system and the inverter.

Battery protocol selection:

Select the interface and communication protocol matching with the inverter on the battery APP or the home page of the display (Protocol options include Hanchu ESS、General、General 1.21、AISWEI、SOFAR SOLAR、Luxpower、DCDC、Solis).

Method 1: Select the interface and communication protocol that matches the inverter on the APP of the battery, see 4.6.3 for the APP selection method.

Method 2:

Protocols can be selected by clicking on the Protocol Interaction screen on the home page of the display.

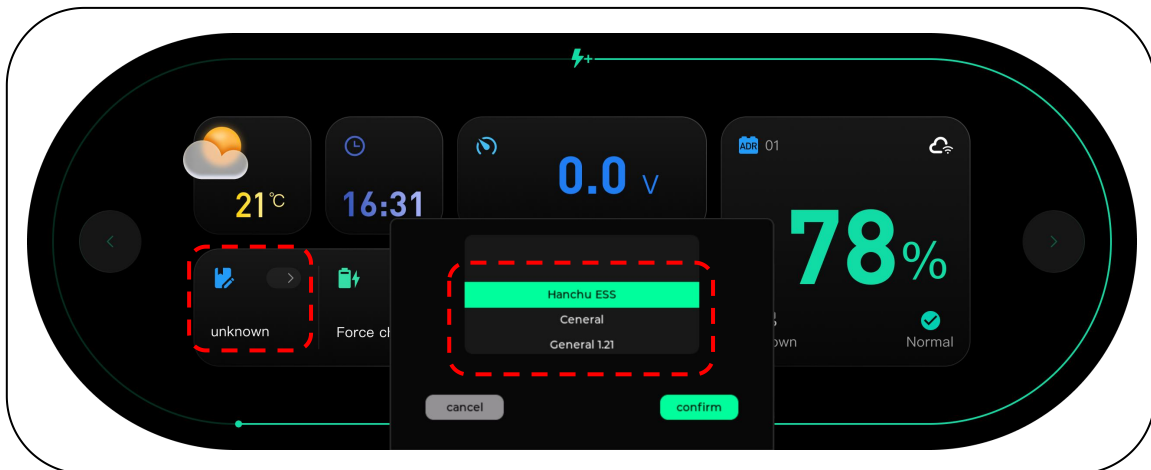

Figure 35 Protocol Selection On The Display

After the setting is completed, you can see the normal status information of the battery system from the inverter, such as voltage, SOC .

➤ 4.6.4 Application Connections

Please download the HanchuESS app by scanning the QR code or from the APP Store.

Step 1: Register and login

Tap "Sign up", after filling in the information, click on "Confirm" to log in.

If you have already registered, you can tap "Sign in" in directly as shown in Fig. 36.

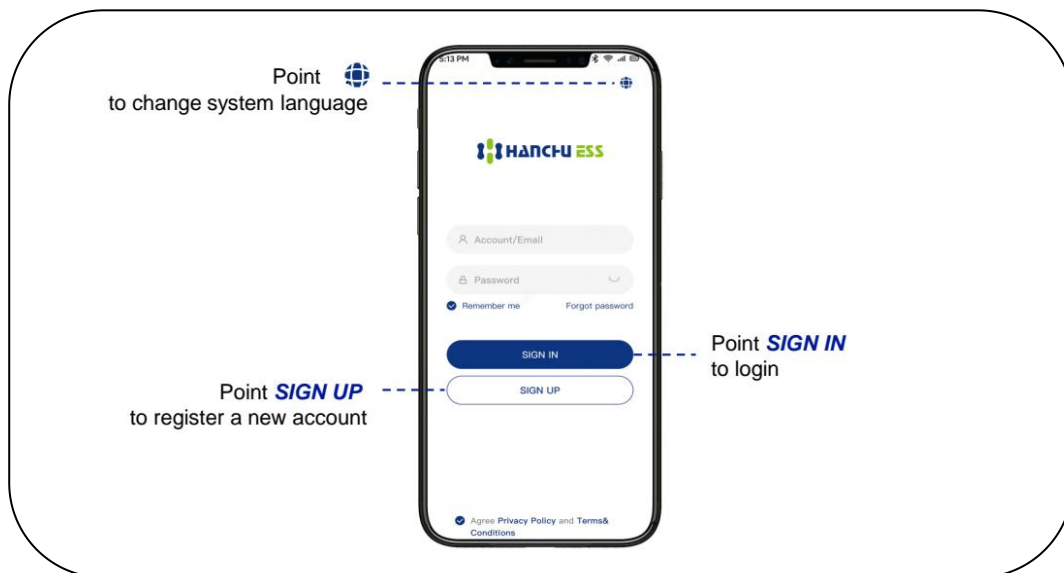

Figure 36

Step 2: Create station

Tap "Create station" on the page, as shown in Fig. 37. You will need to fill in information for the new station, as shown in Fig. 38.

If you have a station, but need to add new devices to your station. Please tap the "+" button to add devices to your station, as shown in Fig. 39.

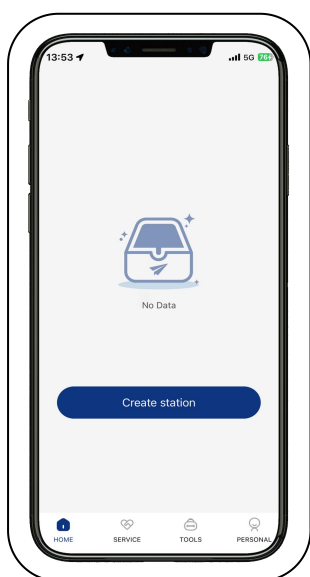

Figure 37

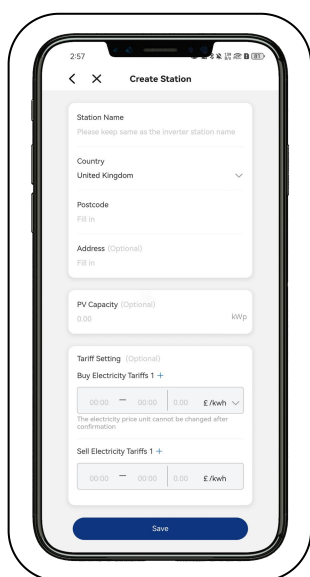

Figure 38

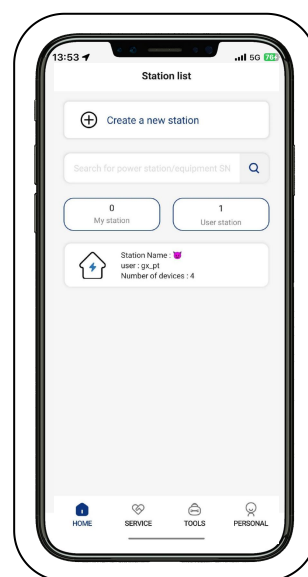

Figure 39

Step 3: Batteries on line

Click on the WIFI menu on the battery display, select the WiFi network you want to connect to, enter the WiFi password and bring the battery system online. See 4.7.3 for details.

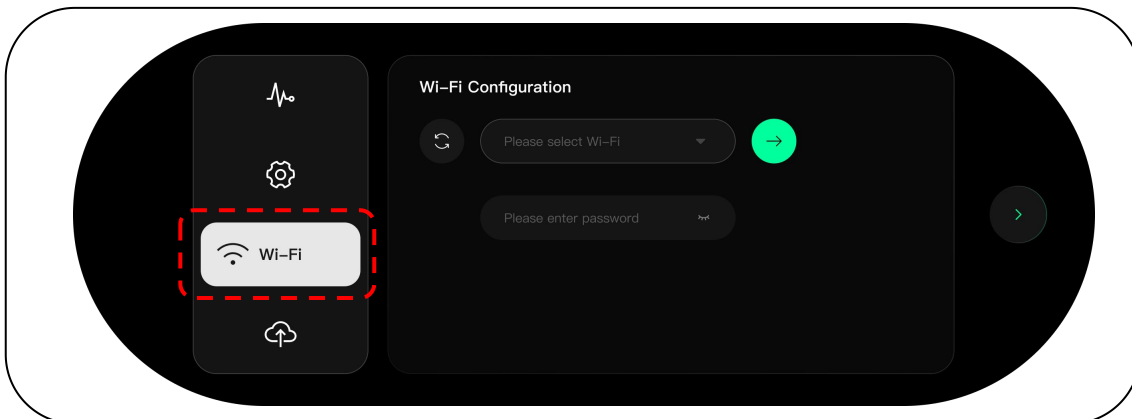

Figure 40

Step 4: Device search

After the battery is successfully online, you can search for the battery in this interface as shown in the Fig 41.

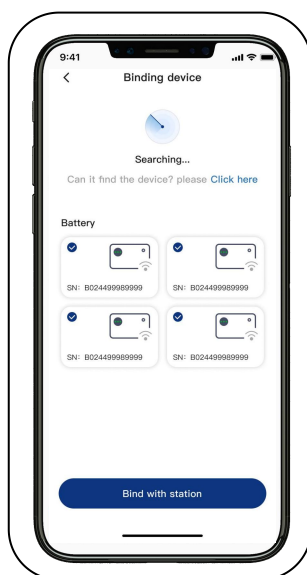

Figure 41

Step 5: Enjoy smart energy

- After completing the above steps, you can view the battery data in HanchuESS app, as shown in Fig. 42.
- Then enter the Battery Setting page, as shown in Fig.43, and you can upgrade the battery online and select the inverter protocol, etc.
- Click "Confirm" to complete the setting, as shown in Fig 44. And more smart functions are waiting for you to discover.

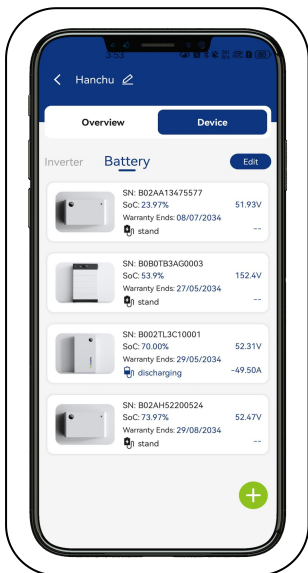

Figure 42

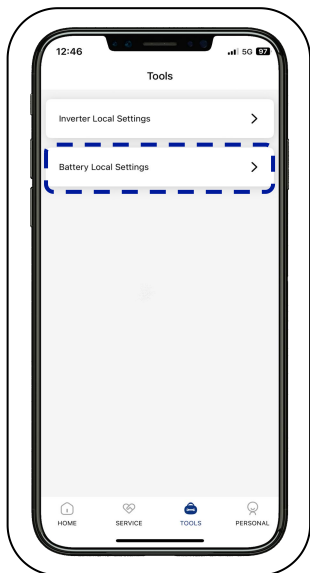

Figure 43

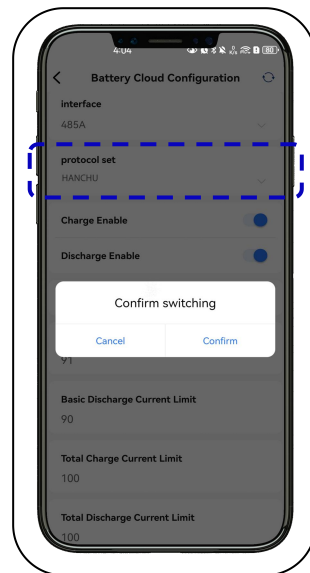

Figure 44

➤ 4.6.5 Equipment Power Down

- 1) First, turn off the inverter.
- 2) Turn off the power switch of the subordinate battery system and the primary battery system in turn. The battery system is in “Standby” after completing “Power off”.
- 3) Turn off the circuit breaker switch on the BDU in the order of the Primary Battery System, Subordinate Battery System 1, Subordinate Battery System 2 and Subordinate Battery System 3.

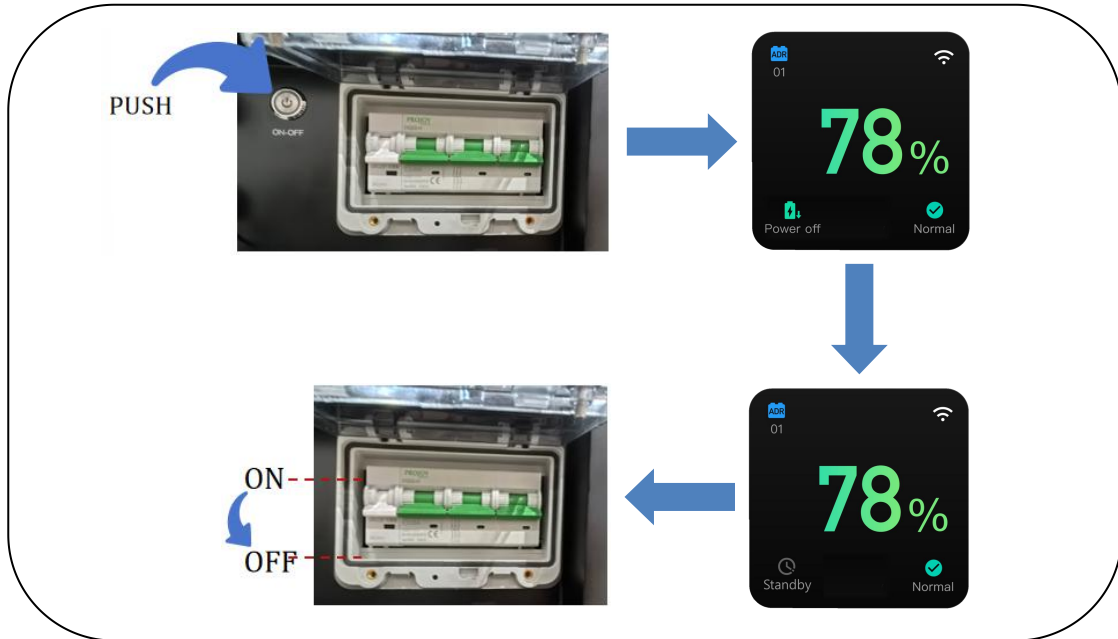

Figure 45

Note: There is an inherent self-discharge loss of the battery system after it has been de-energised. If the battery system does not require work, it is recommended that the button be switched off and the circuit breaker be set to OFF, otherwise damage to the battery due to over-discharge may result.

4.7 Intelligence Touch Display

➤ 4.7.1 Intelligent Touch Display Home

After the stacking installation is completed, turn on the circuit breaker on the BDU and the display will show its home page. The main page of the display can show common operating status data such as voltage, SOC, temperature, charge/discharge current.

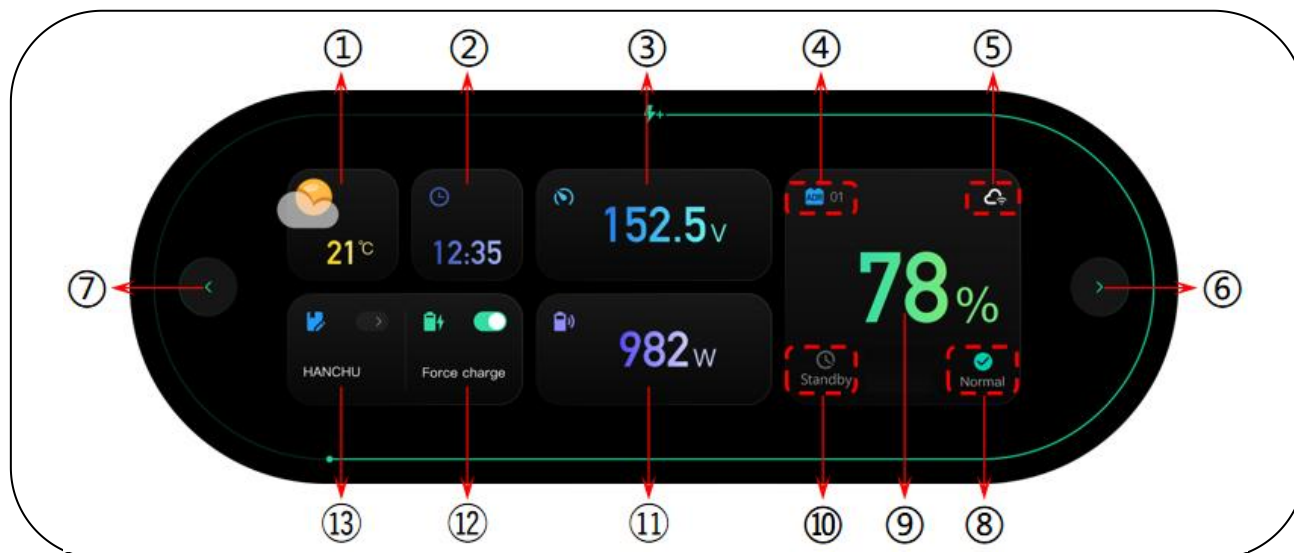

Figure 46 Display Home

Table 14 Display Home Information

NO.	Name	Description	
①	Weather Information	Displaying the weather information	
②	Time	Displaying the current time	
③	Voltage	Displaying the current voltage	
④	ADR	01	The primary battery address bit
		02	The subordinate battery address bit
		03	
		04	
⑤	Cloud Symbol	Displaying the status of connection to the cloud	
⑥	Right page turn key	Click to enter the real-time data page	
⑦	Left page turn key	Click to enter the menu page	
⑧	Abnormal Status	Normal	Indicates if the battery system is in an abnormal state
		Alarm	
		Fault	
⑨	SOC	Display real-time SOC of the battery system	
⑩	System Status	Standby	Indicates the operational status of the battery system
		Power On	
		Charging	
		Idle	

		Discharging	
		Power Off	
⑪	Power	Displaying the current power	
⑫	Force charge	Tap to switch on and off the strong charging button	
⑬	Protocol	Click to match the protocol	

- When the system is charging, the current data is shown below.

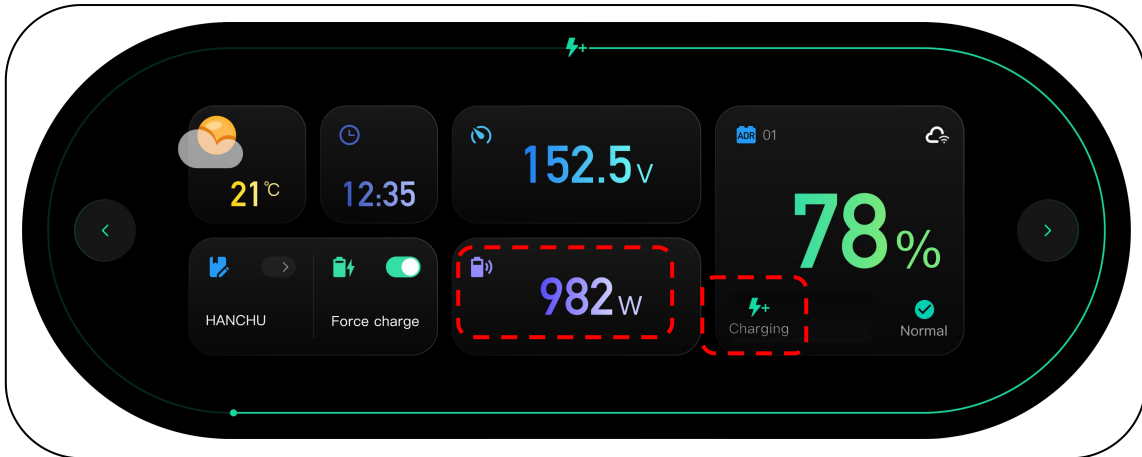

Figure 47 Charging Interface

- When the system is discharging, the current data is shown below.

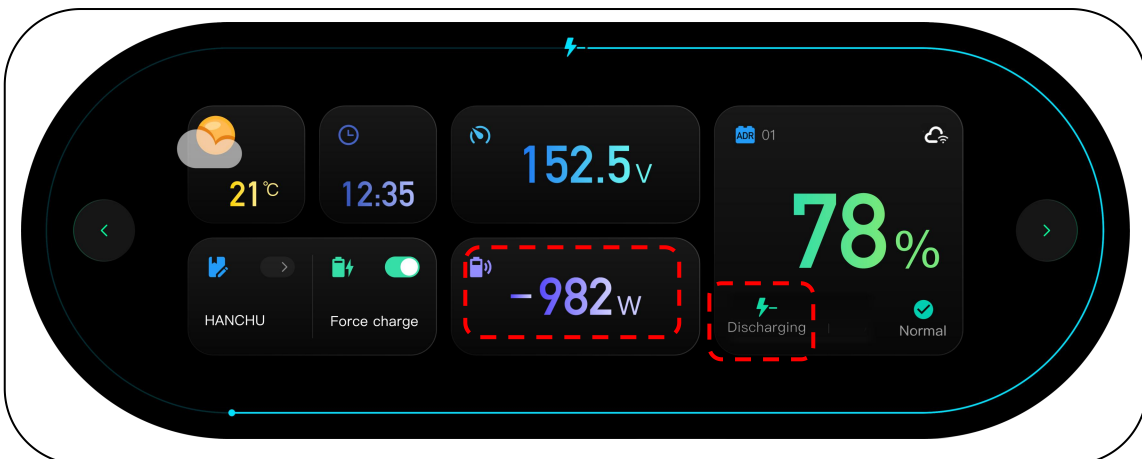

Figure 48 Discharging Interface

- **Force charge**

Forced charging of batteries by skipping program settings in some cases. For example, charging can be forced when the cell voltage is too low.

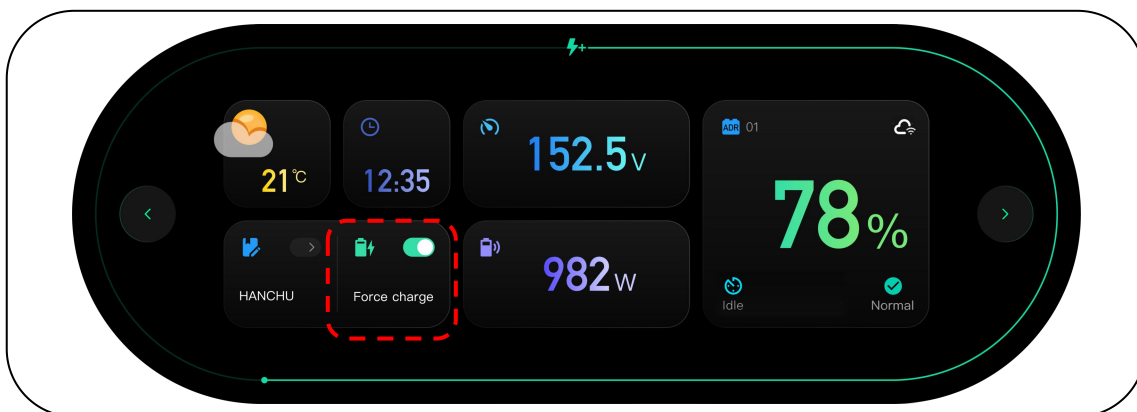

Figure 49 Force Charge

➤ **4.7.2 Real-time Data On Common Operating States**

Tap "△" on the right side of the screen, real-time operating data for voltage, power, temperature, SOC, and relay status can also be viewed on the display.

- The real-time data display of voltage operation status is shown below.

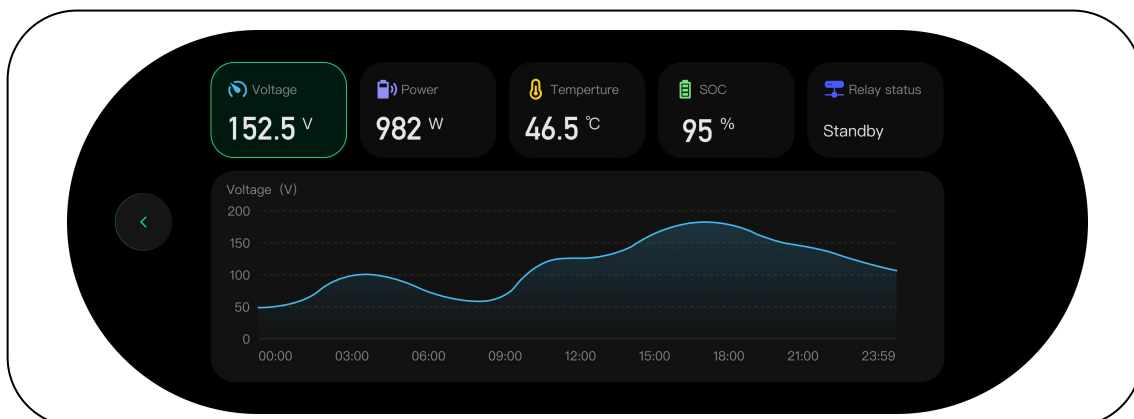

Figure 50

- The real-time data display of power operation status is shown below.



Figure 51

- The real-time data display of temperature operation status is shown below.



Figure 52

- The real-time data display of SOC operation status is shown below.

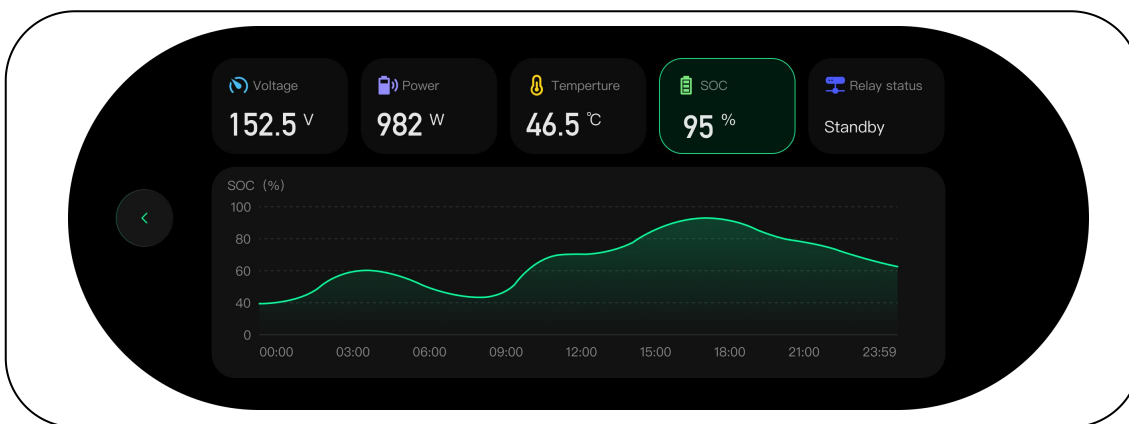

Figure 53

- The real-time data display of relay status operation status is shown below.

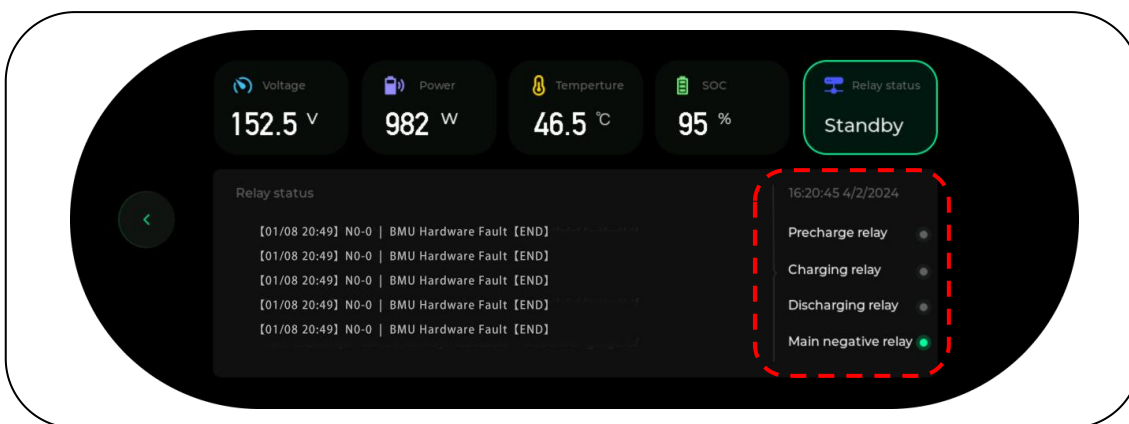

Figure 54

➤ 4.7.3 Interactive Functions

Tap "△" on the left side of the screen, you can enter the interactive function page of the display.

● Information

Touch the "Information" option in the menu bar. You can view the battery system name, number of stacked modules, SN code, firmware version, battery voltage, battery capacity and other information.

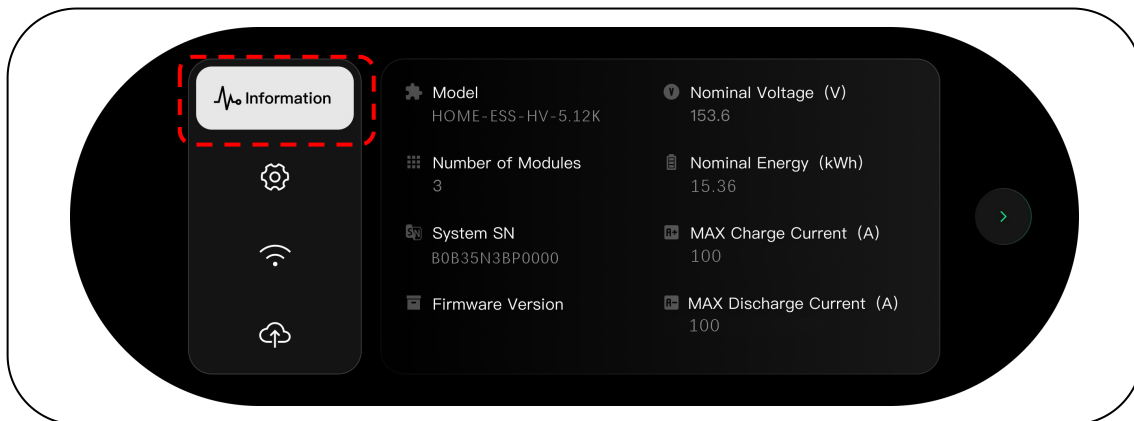

Figure 55 Information Display Interface

● Setting

Touch the "Setting" option in the menu bar. You can set the HMI and the basic information of the battery.

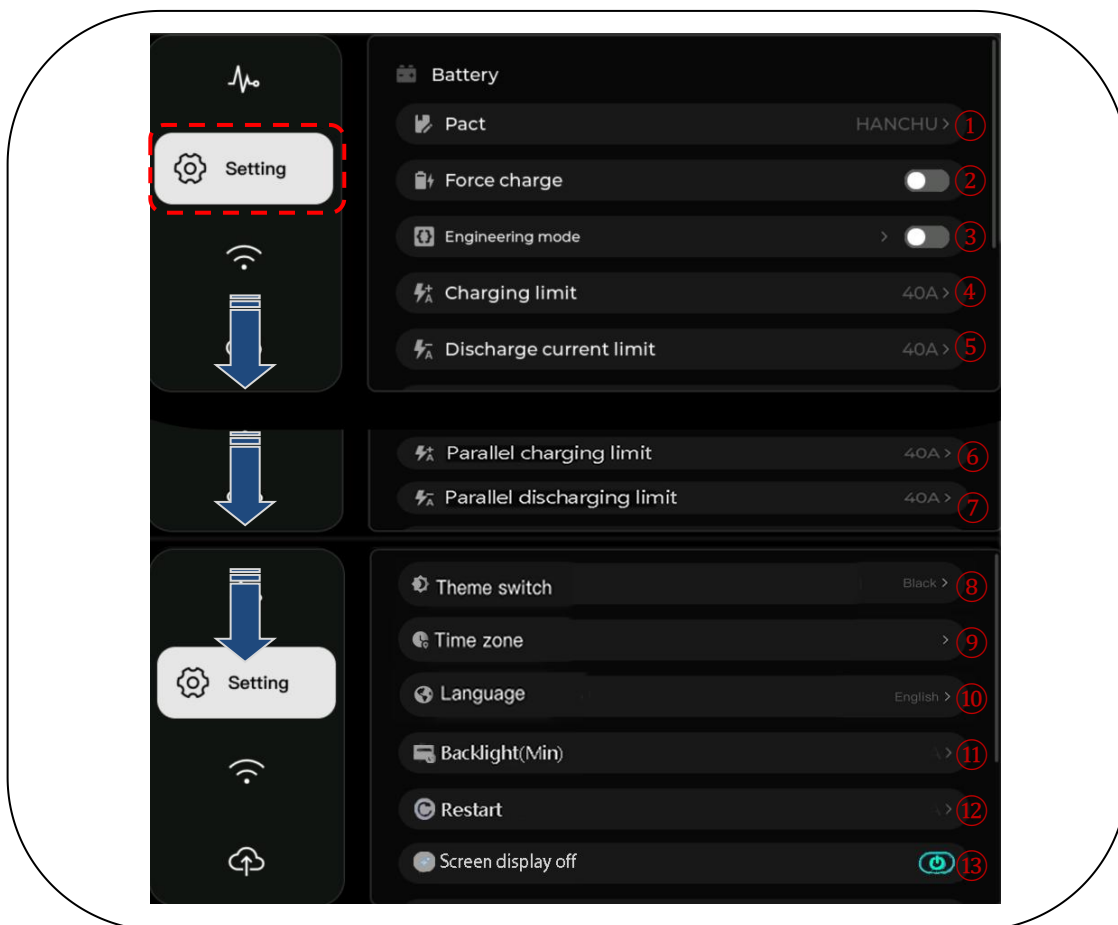

Figure 56 Information Display Interface

Table 15 Setting Information

NO.	Name	Description
Battery		
①	Protocol	You can select the matching protocol
②	Force charge	Click to switch on and off force charge
③	Engineering mode	A password is required to turn on the engineering mode to switch the state of the relay
④	Charging limit	You can set the maximum charge current here
⑤	Discharge current limit	You can set the maximum discharge current here
⑥	Parallel charging limit	You can set the maximum parallel charge current here
⑦	Parallel discharge current limit	You can set the maximum parallel discharge current here
HMI		
⑧	Theme switch	You can switch themes here
⑨	Time zone	You can make time zone and time corrections here
⑩	Language	You can switch languages here
⑪	Backlight(Min)	You can switch the backlight here
⑫	Restart	You can restart the screen here
⑬	Screen display off	Tap to put the screen to rest now

Note:

Only Hanchu ESS professional maintenance personnel are allowed to operate the “Engineering mode”. Private operation by other persons is prohibited. If it is operated by other persons, we are not responsible for any damage to the battery and any risk that may arise .

• WIFI

- 1) Touch the "WIFI" option in the menu bar, the display is shown in Figure 57.
- 2) Click the drop-down menu to select the WiFi you want to connect to, as shown in Figure 58.
- 3) Enter the password and click Confirm, as shown in Figure 59.

When the connection is successful, a WiFi signal appears at the top of the home page of the display.

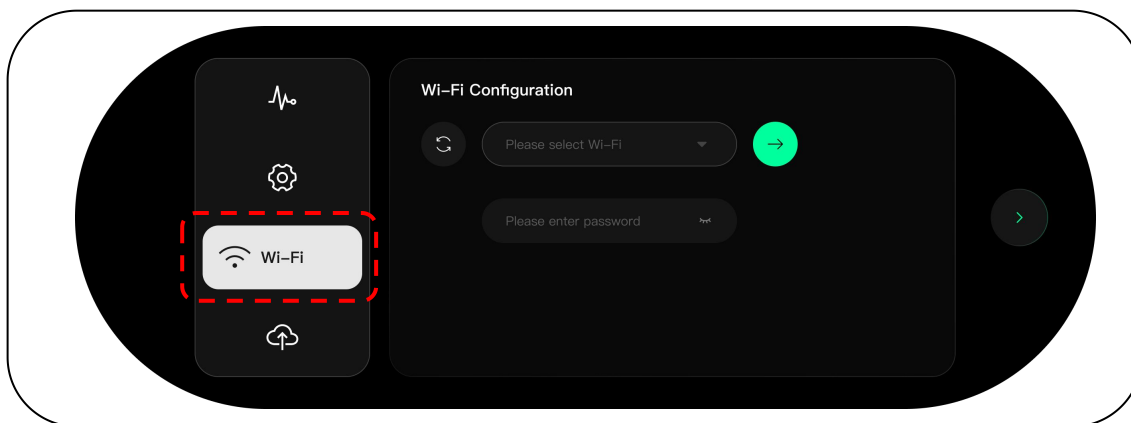

Figure 57

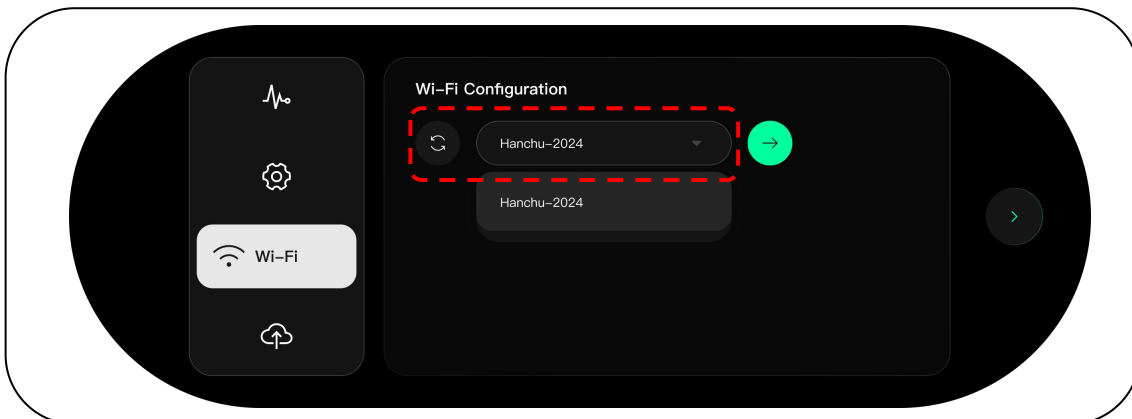

Figure 58

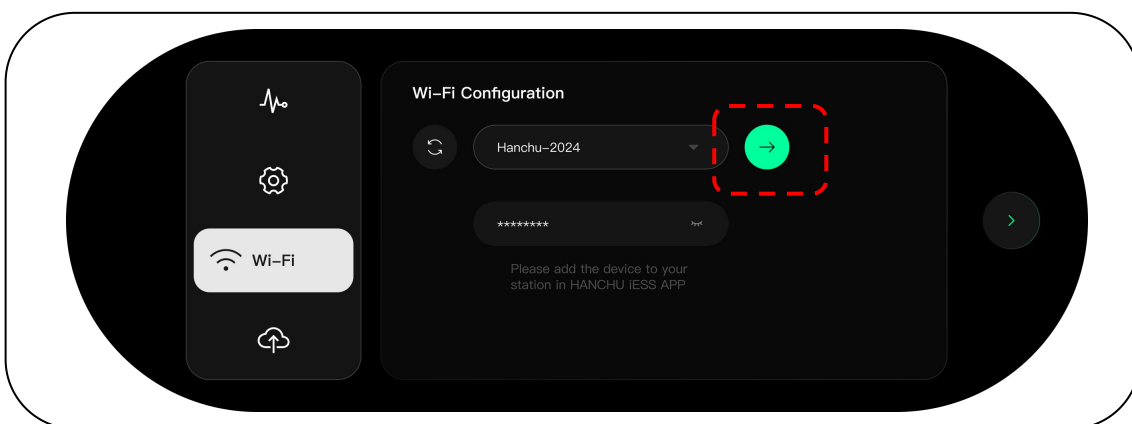

Figure 59

• OTA

Touch the "OTA" option in the menu bar, the display is shown in Figure 58. In this interface, you can choose to upgrade BCU version, WIFI module version and LCD version to the latest version remotely, as shown in Figure 60.

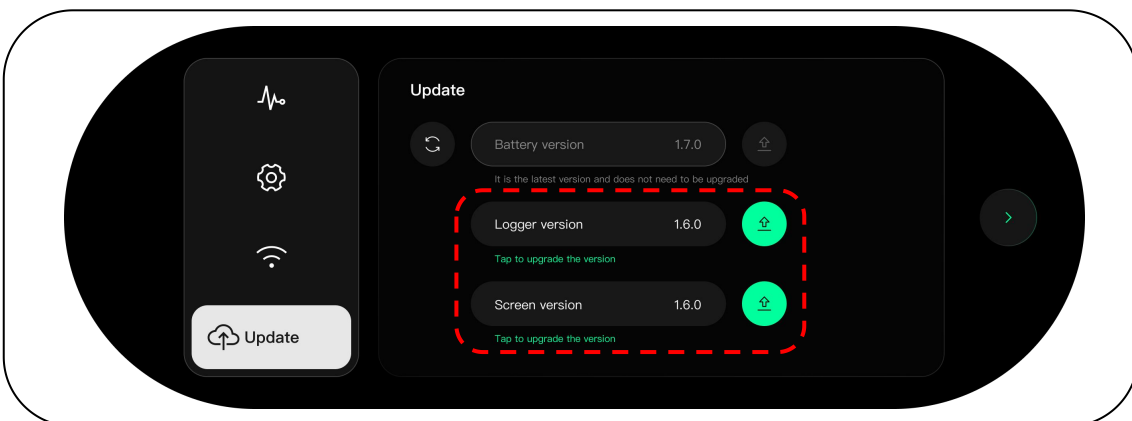

Figure 60 OTA Options Screen Details

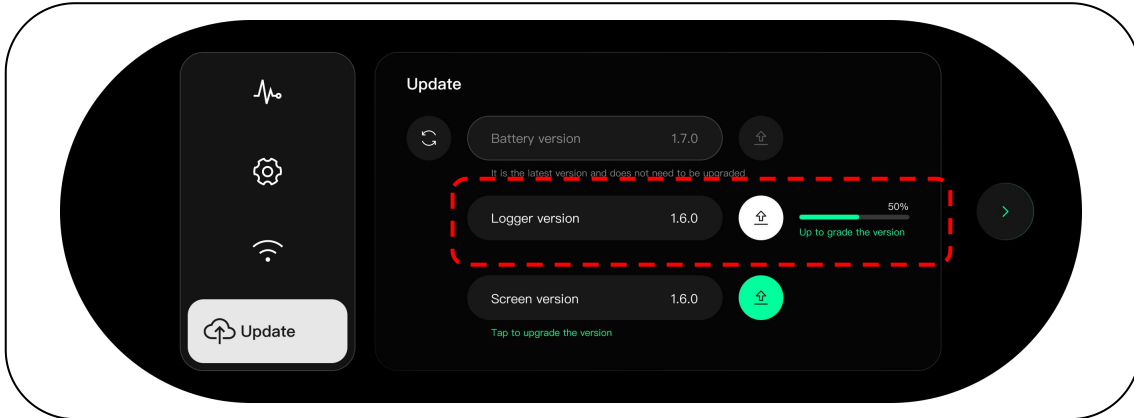

Figure 61 OTA Upgrade in Progress

Note: Upgradation requires network.

• Alarm

1) Touch the "Alarm" option in the menu bar, the display is shown in Figure 62. This feature displays current system faults and also allows you to read and view problems that have occurred in the recent operation of the battery system.

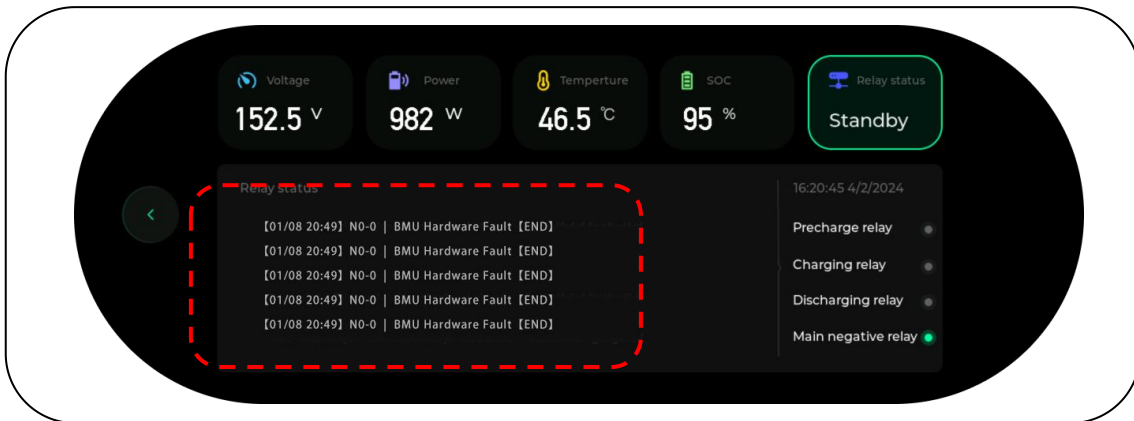

Figure 62 Alarm Options Screen Details

2) Alarms are categorised as alarms and maintenance alarms. Alarms are denoted as N2-X and E-X, and maintenance alarms are denoted as N0-X. Alarms and maintenance alarms are shown in the table.

Table 16 Alarms Information

Level 2 Alarm	Level 3 Alarm	Alarms
N2-1	E-1	Low discharge temperature
N2-2	E-2	High individual cell voltage
N2-3	E-3	Low individual cell voltage
N2-4	E-4	Large cell voltage deviation
N2-5	E-5	Low State of Charge
N2-6	E-6	High State of Charge

N2-7	E-7	High electrode temperature
N2-8	E-8	High charging current
N2-9	E-9	High discharge current
N2-10	E-10	Large temperature difference
N2-11	E-11	Low insulation
N2-12	E-12	High total voltage
N2-13	E-13	Low total voltage
N2-14	E-14	High charging temperature
N2-15	E-15	Low charging temperature
N2-16	E-16	Rapid temperature rise
N2-17	E-17	High pack voltage
N2-18	E-18	Low pack voltage
N2-19	E-19	High fuse temperature
N2-20	E-20	High shunt temperature

3) Maintenance alarms are shown in the table.

Table 17 Maintenance Alarms Information

Index	Maintenance Alarms
N0-0	BMU Hardware Fault
N0-1	BMU Battery Fault
N0-2	Communication Failure with BMU
N0-3	Temperature Sensing Fault
N0-4	Main Negative Contactor Fault
N0-5	Main Positive Contactor Fault
N0-6	Precharge Failure
N0-7	Fuse Fault
N0-9	Current Loop Damage
N0-10	Invalid Total Voltage Acquisition
N0-11	Abnormal Increase in Individual Cell Voltage
N0-12	Extremely High Individual Cell Voltage
N0-13	Extremely Low Individual Cell Voltage
N0-14	Extremely High Temperature
N0-15	Relay Strong Control
N0-16	Large Inter-cluster Pressure Difference

N0-17	Abnormal Communication with Main Controller
N0-18	Communication Failure with EMS
N0-19	PCS/EMS Strong Control Relay
N0-20	Communication Failure with PCS
N0-22	Battery Cluster Not Enabled
N0-23	Insufficient Number of Battery Clusters in Place
N0-24	Excessive Number of Battery Clusters in Place
N0-25	Charging Relay Fatal
N0-26	System restart
N0-27	DisCharging Relay Fatal
N0-28	Thermometer failure
N0-29	Passive equilibrium Err
N0-30	Parallel Err
N0-31	SBCU-QF Fault

5 Common Troubleshooting

Table 18 Common Troubleshooting

Accident	Fault description	Solution
Display does not light up	After the battery modules, base and BDU stacking is completed, turn on the circuit breaker, the display does not light up	Check that the connectors between the BDU and the module are mated in place. If restacking does not work, please contact Hanchu ESS after-sales service or your distributor directly.
No DC Output	Charging and discharging are not possible when connected to a power source.	Check whether the breaker and the power switch is switched on. If it is switched on and charging/discharging is still not possible, please contact Hanchu ESS after-sales service department or your dealer directly.
External communication Errors	The communication interruption between BMS and inverter.	Check if the communication cable between BDU and inverter is correct and well connected.
Internal communication Errors	Communication between battery groups is interrupted.	Check that the communication cables between the parallel battery systems are correct and well connected.
Over Voltage Alarm	Battery voltage is too high .	Wait for the battery voltage to return to normal.
Lower Voltage Alarm	Battery voltage is too low.	Please click the Forced Charging pattern on the display to charge the battery, if it does not work please contact Hanchu ESS after-sales service or your dealer directly.
Charge OCP	Battery charging over current protection.	Please contact Hanchu ESS after-sales service department or your dealer directly.
Discharge OCP	Battery discharge over current protection.	Please contact Hanchu ESS after-sales service department or your dealer directly.
High Temperature Protection	Battery temperature is too high.	Wait for the cell temperature to return to normal.
Low Temperature Protection	Battery temperature is too low.	Wait for the cell temperature to return to normal.
Cell Imbalance	The capacity of the battery is different.	Please contact Hanchu ESS after-sales service department or your dealer directly.

Insulation Fault	Battery insulation failure.	Stop using immediately and turn off the circuit breaker switch. Please contact Hanchu ESS after-sales service department or your dealer directly.
VoltSensor Fault	Battery voltage acquisition failure.	Please contact Hanchu ESS after-sales service department or your dealer directly.
TempSensor Fault	Battery temperature acquisition failure.	Please contact Hanchu ESS after-sales service department or your dealer directly.
Temperature difference alarm	The temperature between cells are different.	Stop charging and discharging, and check for heat source interference around the working environment, if not, please contact Hanchu ESS after-sales service department or your dealer directly.

6 Battery Maintenance

6.1 Battery Storage Requirements

The battery is required to be stored in a temperature range from 0°C to +40°C. Routine maintenance is required for batteries that have been stored for a long time. Depending on the storage time of the battery and the storage environment, Please charge the battery to the corresponding SOC at 0.2C as required by the table below.

Table 19 Battery Storage Requirements

Ambient temperature	Relative humidity in storage environment	Storage time	SOC
<0°C	/	Prohibited	/
0~40°C	5%~60%	≤1month	15%≤SOC≤40%
5~35°C		≤6month	30%≤SOC≤60%
>45°C	/	Prohibited	/

- After a long-time storage, the battery should be inspected and tested by professionals before use.
- During the storage period, record temperature, humidity and storage environment in accordance with storage requirements in this manual.
- Long-term storage of batteries is not recommended, which will cause capacity loss. Generally, after 12 months of storage at the recommended storage temperature, an irreversible capacity loss of lithium batteries is 3%~10%.
- The batteries should be stored in accordance with the labels on the packaging box and should not be inverted or placed sideways.
- The battery boxes should be stacked according to the stacking requirements on the outer packaging.
- When handling the battery, take care not to damage the battery.
- Storage Environment Requirements :
 - Ambient temperature: short-term storage (less than 1 month)0°C~40°C, long-term storage (more than 1 month)5°C~35°C. Recommended storage temperature: 20°C~30°C.
 - Relative humidity: 5%RH~60%RH.
 - Store products in a dry, clean and ventilated place. Keep them away from dust, direct sunlight, rain, vapor or groundwater.
 - Avoid contact with corrosive organic solvents, gases and other substances.

6.2 Charging Requirements After Over-discharge

The battery stops discharging there is still static power consumption of the internal battery module and its own self-discharge loss, if there is no charge for a long time to replenish, it may lead to battery damage due to over-discharge. When the battery SOC is low, it needs to be replenished according to the maximum interval in the following table.

Table 20 Lithium Battery Recharge Cycle

SOC at power down before storage	Maximum recharge interval
SOC<5%	24h

We do not provide warranty service for permanent battery failure due to overdue recharging by the customer.

6.3 Long-term Idle Maintenance Requirements

If a long period of inactivity (≥ 30 days) is planned, the following two requirements should be observed to protect the battery:

- 1) Ensure that the battery's SOC system is above 30% and that the battery circuit breaker and power switch remain off.
- 2) If it is stored for more than 30 days, due to different temperature and different storage time, it has different effects on self-discharge. Therefore, before the batteries go online, it is necessary to check the voltage completely to confirm the necessity of maintaining the state of charge, our company can assist the customer to make a judgment.
- 3) If the interval between two charges of the battery exceeds 2 months, the standard charging mode should be adopted for 2~3 times before the the battery performance can reach the best state.
- 4) If it is stored for more than 3 months, it shall be tested and maintained every 3 months. If it is not tested or maintained for more than 9 months, Hanchu will not be responsible for quality protection for capacity loss or other defects caused by batteries.

Note: We do not provide appropriate warranty service for permanent battery failure due to improper storage by the customer.

6.4 Battery Maintenance Safety Requirements

When the equipment is running, a high voltage may cause electric shocks and result in death, serious injury or property damage. Before performing maintenance, turn off the equipment and strictly follow the safety precautions listed in this manual and other related documents.

- Ensure that you are familiar with the contents of this manual and have appropriate tools and test equipment to perform maintenance.
- Before performing maintenance, turn off the equipment according to the instructions and wait for a certain period of time to ensure that the equipment is power-off .
- During maintenance, prevent unnecessary personnel from getting close to the maintenance site. Temporary warning signs or fences must be erected to isolate the site.
- If the equipment fails, please contact your dealer in time to deal with it.
- The equipment can only be power-on again after the fault has been dealt with. Otherwise, the equipment may have some problems or become damaged.
- Do not disassemble the product without authorization. There is a danger of electric shocks and the corresponding failure is not covered by the warranty.
- Maintenance personnel should have received the professional training and use protective tools to conduct maintenance.
- When it is necessary to move or rewire, the input power must be cut off. Wait for 5 minutes to ensure that the internal energy of the machine has been discharged. The maintenance should be started after

confirming with a multimeter that there is no dangerous voltage and no parts need to be repaired inside the machine.

- Maintenance of batteries should be performed or supervised by someone who is familiar with batteries and required precautions.

- Please use the same type of cell when replacing cells.

- After maintenance, immediately check that no tools or other parts have been left inside the equipment.

- If the equipment has not been used for a long time, you need to store and charge the battery according to this manual.

All operators of the energy storage system shall comply with the user manual. Any equipment damage caused by neglecting or misreading the user manual, will void the product warranty.

7 Technical Data

Table 21 Technical Data

	HOME-ESS-HV-15.36~61.44K
Cell Type	LFP(LiFePO4)
Module Energy (kWh)	5.12
Module Weight (kg)	43
Number of Modules	3~12
Charging Temperature (°C)	0~50
Discharging Temperature (°C)	-10~60
Environment Temperature (°C)	Charge: 0~40 Discharge: -10~40
Depth of Discharge	95% DOD
Nominal Charge/Discharge Current (A)	100
Max. Charge/Discharge Current (A)	100
Cycle Life	>6000, 25°C
Enclosure Protection Rating	IP65
Cooling Type	Natural convection
Humidity	5%~95%
Altitude	<2000
Communication	CAN/RS485/WIFI/Bluetooth
Certification	IEC 62619/EN61000/UN38.3

Table 22 Technical Data

	HOME-ESS-HV-15.36K	HOME-ESS-HV-20.48K	HOME-ESS-HV-25.6K	HOME-ESS-HV-30.72K	HOME-ESS-HV-35.84K
Number of Modules	3	4	5	6	7
System Structure					
Nominal Energy (kWh)	15.36	20.48	25.6	30.72	35.84
Nominal Voltage (V)	153.6	204.8	256	307.2	358.4
Operating Voltage Range (V)	144-172.8	192-230.4	240-288	288-345.6	336-403.2
Dimension(W*D*H) (mm)	650*355*812	650*355*995	650*355*1178	650*355*1361	650*355*1544
Weight (kg)	148	191	234	277	320
Battery Designation	IFpP51/161/1 19[48S]M/- 20+40/95	IFpP51/161/1 19[64S]M/- 20+40/95	IFpP51/161/1 19[80S]M/- 20+40/95	IFpP51/161/1 19[96S]M/- 20+40/95	IFpP51/161/1 19[112S]M/- 20+40/95
	HOME-ESS-HV-40.96K	HOME-ESS-HV-46.08K	HOME-ESS-HV-51.2K	HOME-ESS-HV-56.32K	HOME-ESS-HV-61.44K
Number of Modules	8	9	10	11	12
System Structure					

Nominal Energy (kWh)	40.96	46.08	51.2	56.32	61.44
Nominal Voltage (V)	409.6	460.8	512.0	563.2	614.4
Operating Voltage Range (V)	384-460.8	432-518.4	480-576	528-633.6	576-691.2
Dimension(W*D*H) (mm)	650*355*1727	650*355*1910	650*355*2093	650*355*2276	650*355*2459
Weight (kg)	363	406	449	492	535
Battery Designation	IFpP51/161/1 19[128S]M/- 20+40/95	IFpP51/161/1 19[144S]M/- 20+40/95	IFpP51/161/1 19[160S]M/- 20+40/95	IFpP51/161/1 19[176S]M/- 20+40/95	IFpP51/161/1 19[192S]M/- 20+40/95



Android APP



iOS APP

Jiangsu Hanchu Energy Technology Co., Ltd

No.9, Huicheng Road, Huishan District, Wuxi City, Jiangsu
Province, China

Hotline:+86-51088876668/+86-51088865288

Email:service@hanchuess.com

Web:www.hanchuess.com