

Hybrid Inverter User Manual

LXP 3-6K

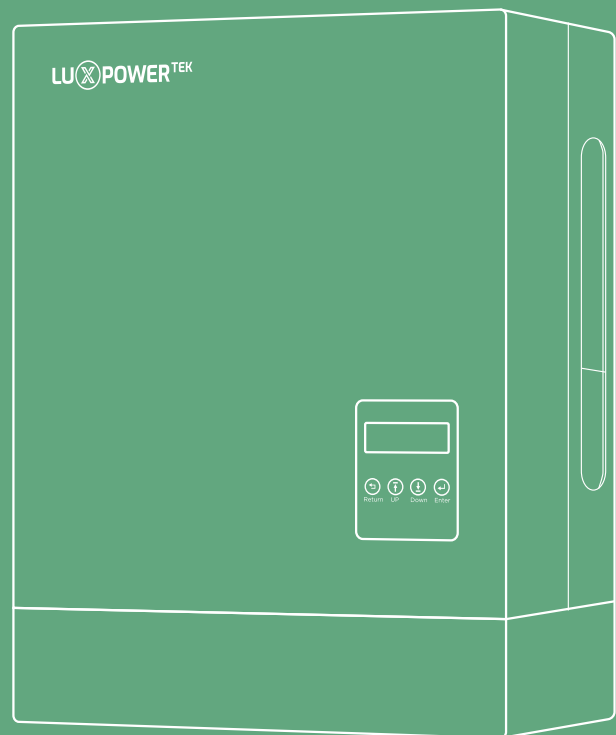

LUX POWER^{TEK}

Copyright© 2024 Lux Power Technology Co., Ltd. All Rights Reserved. This manual, protected by the copyright and intellectual property rights of Lux Power Technology, may not be modified, copied, or reproduced without prior written permission. Brands and trademarks mentioned belong to their respective owners. Read carefully for product reliability and warranty eligibility. For warranty details, refer to Lux Power Technology Limited Warranty. Intended for professional service providers; no statements constitute an express or implied warranty.

Descriptions may contain predictive statements; differences may occur. Provided for reference, subject to change without notice by Lux Power Technology.



Website



YouTube



Facebook

 www.luxpowertek.com



Scan to download

CONTENT

- About This Manual 1
- 1. Safety** 1
 - 1.1 Symbol Explanation 1
 - 1.2 Safety Instruction 1
- 2. Brief Introduction** 4
 - 2.1 System Solution 4
- 3. Installation** 5
 - 3.1 Packaging List & Storing 5
 - 3.2 Select Location 6
 - 3.3 Install the Inverter 8
 - 3.4 Connection 9
 - 3.4.1 Connection Overview 9
 - 3.4.2 PV Connection 10
 - 3.4.3 Battery Connection 12
 - 3.4.4 Grid Connection 14
 - 3.4.5 UPS/Back-up Connection 15
 - 3.4.6 Meter and CT Connection 16
 - 3.4.6.1 Connect the Meter 17
 - 3.4.6.2 Connect the CT 18
 - 3.4.7 Communication Connection 18
 - 3.6.7.1 DRMs Connection 19
 - 3.6.7.2 Safety Standard Configuration – SW2 19
 - 3.6.7.3 Balancing Resistor Configuration – SW1 21
 - 3.6.7.4 Wireless Communication Module Connection 21
 - 3.4.8 Grounding 22
- 4. Operation** 23
 - 4.1 Operation Mode 24
 - 4.2 LCD operation and settings 24

4.2.1 LCD Menu Structure Overview24

4.2.2 Status and Parameter show in LCD24

4.2.3 LCD Settings26

4.2.3.1 Information Searching26

4.2.3.2 Settings Guidance29

4.3 Monitor System37

4.4 Work with Gen set37

4.5 Parallel System Setup Guidance37

5. Start-up and shut down the inverter40

5.1 Start up the inverter40

5.2 Shut down the inverter40

6. Troubleshooting & Maintenance41

6.1 Troubleshooting41

6.1.1 Introduction to LED Displays41

6.1.2 Maintenance41

6.1.3 Troubleshooting Based On LCD Displays42

Revision History





Version	Date	Description
UM-LXP01001E	2024.07.20	First official release.

1. Safety

1.1 Symbol Explanation









Symbols in This Manual

The general information and safety instruction is highlighted with following symbols in this manual:

	“Danger” indicates a hazardous situation which, if not avoided, will result in death or serious injury.
	“Warning” indicates a hazardous situation which, if not avoided, could result in death or serious injury.
	“Caution” indicates a hazardous situation which, if not avoided, could result in minor or moderate injury.
	“Notice” provides tips that are valuable for the optimal operation of your products.

Symbols on Inverter Label

Following list shows the meaning of all the safety symbols on inverter type label:

			 Beware of hot surface. The inverter can be hot during operating, avoid contact during operating.
CE Mark	RCM Mark	Certification	 Danger of high voltage. Danger to life due to the high voltages in the inverter.
	Risk of electric shock.		 Observe enclosed documentation.
	Danger of high voltage. Residual voltage in the inverter need 5min to discharge, wait 5min before operation.		

1.2 Safety Instruction

General Safety Instructions

The inverter has been designed and tested strictly according to international safety regulations. Read all safety instructions carefully prior to any work and observe them at all times when working on or with the inverter. The operator must be qualified personnel and the installation must be capable with relevant national or international standards or regulations.

Incorrect operation or work may cause:

- injury or death to the operator or a third party;
- damage to the inverter and other properties belonging to the operator or a third party.

Important Safety Notifications

There are many safety issues need to be carefully notified before, during and after the installation, and also in future operation and maintenance, following is important safety notifications to operator, owner and user of this product in appropriate usage.

! DANGER

Dangers of High Voltages and Large Current

- Beware of high PV voltage. Please turn-off the DC switch of PV Panel output before and during the installation to avoid electric shock.
- Beware of high grid voltage. Please turn-off the AC switch of grid connection before and during the installation to avoid electric shock.
- Beware of large current of the battery output. Please turn-off the battery module before and during the installation to avoid electric shock.
- Do not open the inverter when it's working to avoid electric shock and damages from live voltage and current from the system.
- Do not operate the inverter when it's working, only the LCD and buttons can be touched in limited cases by qualified personnel, other parts of the inverter can be touched when the inverter is under a safe state(e.g. fully shut-down).
- Do not connect or disconnect any connections (PV, battery, grid, communication etc.) of the inverter when it's working.
- Make sure the inverter is well grounding, an operator should make sure itself is good protected by reasonable and professional insulation measurements (e.g. personal protective equipment (PPE)).
- Inspect relevant existed wiring on-site of the installation is under good condition before installation, operation or maintenance.
- Inspect the connections are good between inverter and PV, battery and grid during installation to prevent damages or injuries caused by bad connections.

! WARNING

Avoid misoperation and Inappropriate Usage

- All the work of this product (system design, installation, operation, setting and configuration, maintenance etc). must be carried out by qualified personnel as required.
- All connections must be in accordance with local and national regulations and standards.
- Only when permitted by utility grid, the inverter and system can interconnected with the utility grid.
- All the warning lable or nameplate on the inverter must be clearly visible and must not be removed, covered or pasted.
- The installation should choose a right position and location as required in this manual with consideration to safety of users' in future operation.
- Please keep the children away from touching or misoperation the inverter and relevant system.
- Beware of burning hurt, the inverter and some parts of the system could be hot when working, please do not touch the inverter surface or most of the parts when they are working. During inverter working states, only the LCD and buttons could be touched.

⚠ CAUTION

- Only qualified personnel can change the inverter settings.
- There might be possible damage to health as a result of the effects of radiation, do not stay closer than 20cm to the inverter for long time.

● NOTICE

- Please carefully read this manual before any work carried out on this inverter, after the installation, please keep this manual carefully stored and easy to access at any time.
- The qualified personnel should have had training in the installation and commissioning of the electrical system as well as dealing with hazards, also they should have the knowledge of the manual and other related documents. As the installer or operator they are required to be familiar with local regulations and directives.

2. Brief Introduction

2.1 System Solution

This product and relevant system is suitable for following system applications (system diagram):

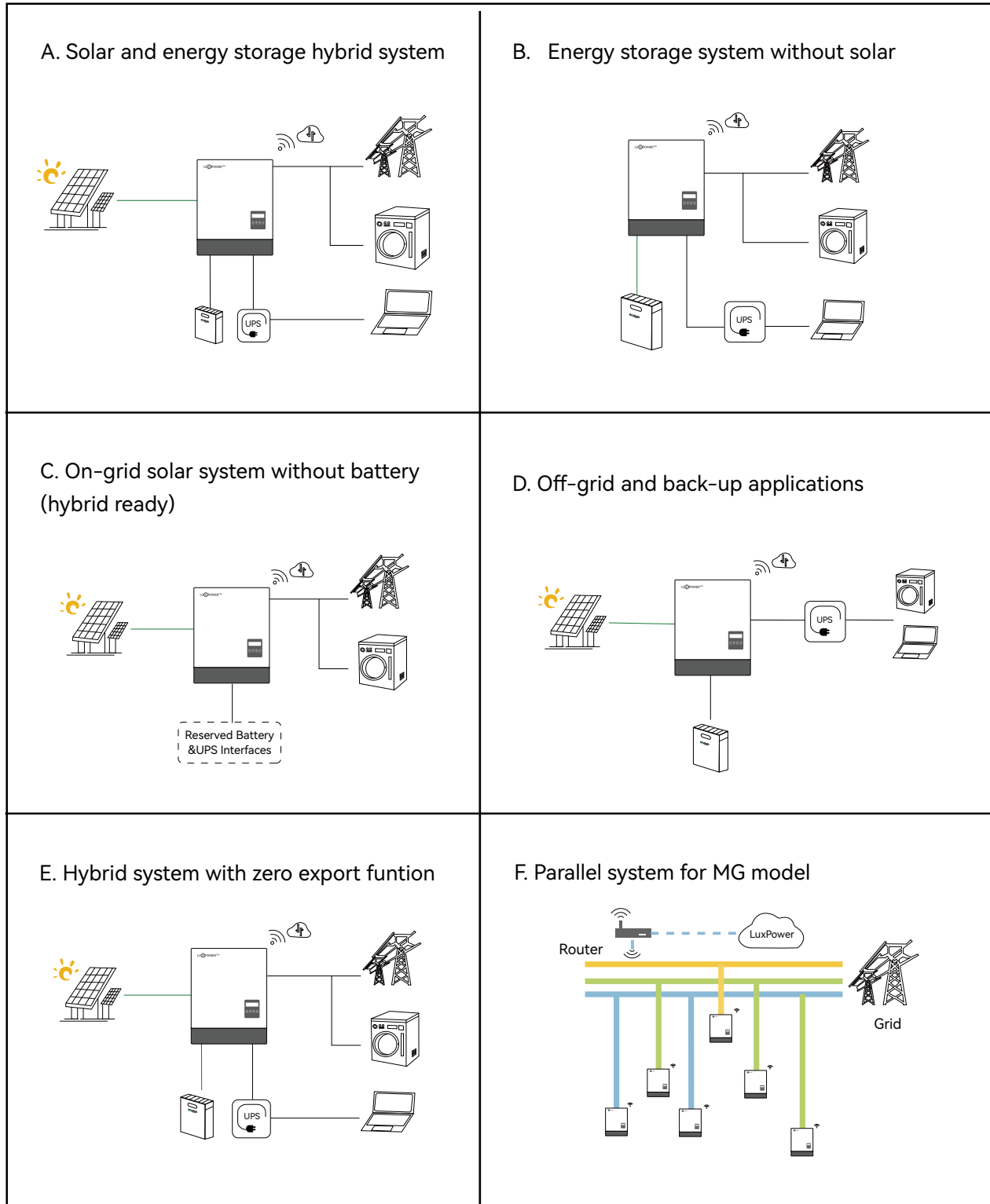





















3. Installation

3.1 Packaging List & Storage Instructions

Packaging List

When the packaging is unpacked, the inner components should be the same as described in below packaging list.

 <p>Hybrid Inverter X1</p>	 <p>User Manual X1</p>	 <p>Wall-mounted Bracket X1</p>	 <p>Rj45 Extension Terminal X4</p>
 <p>Communication Port Cover X1</p>	 <p>Wi-Fi Module X1</p>	 <p>AC Connector X1</p>	 <p>EPS Connector X1</p>
 <p>CT X1</p>	 <p>PV Connector X4</p>	 <p>Rj45 Terminal X4</p>	 <p>Security Screw X1</p>
 <p>4mm Allen Key</p>	 <p>2mm Allen Key</p>	 <p>Connector for BAT+</p>	 <p>Connector for BAT-</p>
 <p>Expansion Screw and Tube X4</p>	 <p>Guardrail barrier</p>	 <p>Cross Head Screw X12</p>	
<p>Quick Installation Instruction</p>		<p>Battery communication cable which is used for Pylontech battery, for other brand battery, please make the cable Expansion Screw Cross Head according to PIN definition</p> 	

Storing the Inverter

The inverter must be stored appropriately if not installed immediately, refer to below figure.

CAUTION

- a) The inverter and its components must be stored in its original packaging.
- b) The storage temperature should be within $-25^{\circ}\text{C} \sim 60^{\circ}\text{C}$ and humidity within 0~85%.
- c) The packing should be upright and maximum stacked layers is 6 .
- d) Do not exposed the inverter and its packaging to directly sunshine, raindrops and keep away from corrosion.

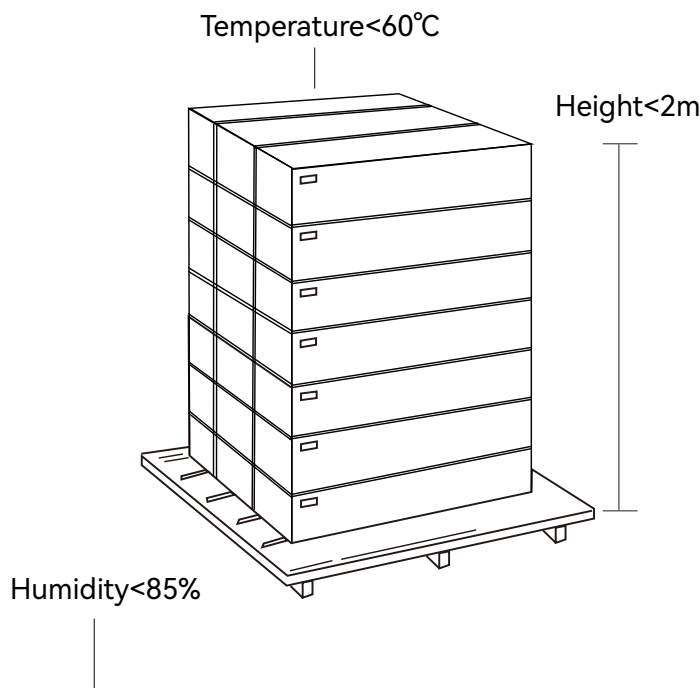

3.2 Select Location

The LXP hybrid inverters are designed as IP65 devices with a capability to be installed in both outdoor and indoor conditions. However, selecting an optimal installation location is highly recommended to increase the safety, performance and lifespan of the inverter. Please note the installation should not be accessible to children for safety consideration.

Suggestions and Requirements

- a) The wall for mounting should be strong enough to bear the weight of inverter .
- b) The ambient temperature is required to be within $-25^{\circ}\text{C} \sim 60^{\circ}\text{C}$.
- c) To ensure the heat dissipation efficiency and inverter lifespan, do not install the inverter enclosed.

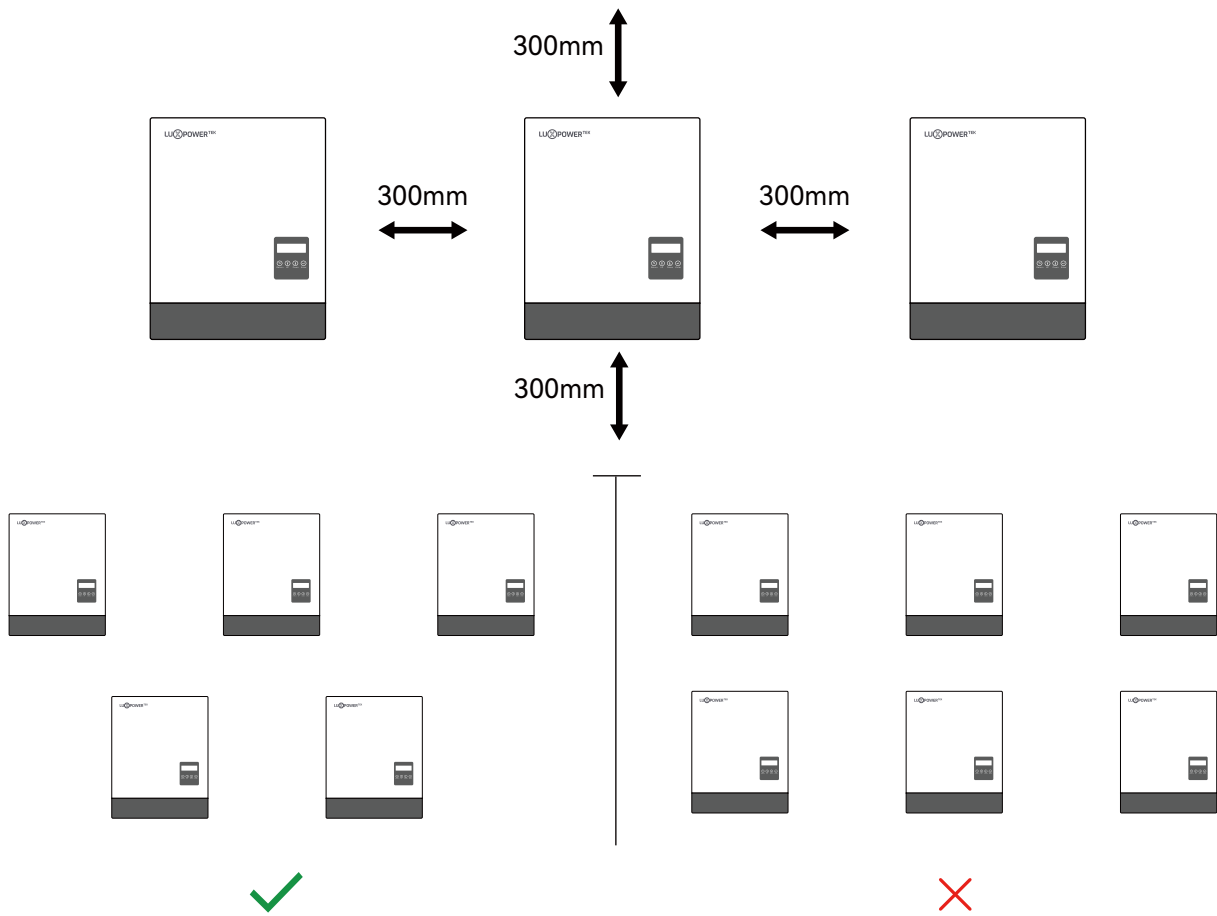

d) The structure of the wall where inverter mounted should not be flammable, or make sure the inverter is not surrounded by flammable or corrosion materials and is away from the gas.

e) Never install the inverter exposed to directly sunshine, rain and snow. Please refer to below figure and select a well shaded place or install a shell to protect the inverter from directly sunshine, rain and snow etc.

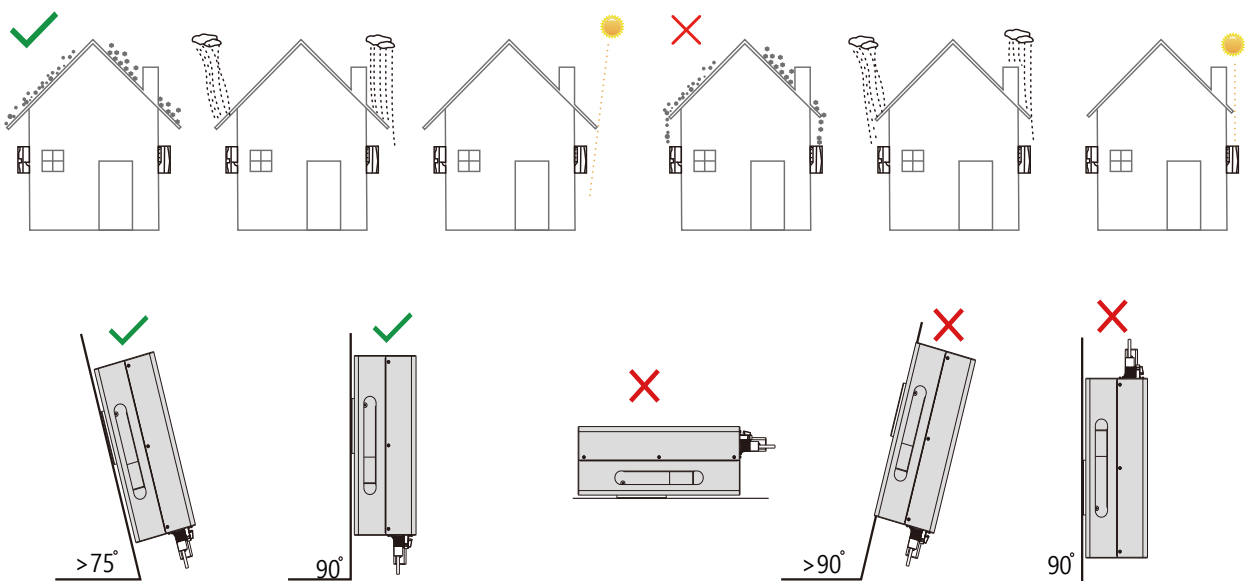

3.3 Install the Inverter

The inverter is wall-mounted installed , steps shows below:

Step 1. Use the wall-mounting bracket as the template to mark the position of the 4 holes, then drill 8 mm holes and make sure the depth of the holes is deeper than 50mm.

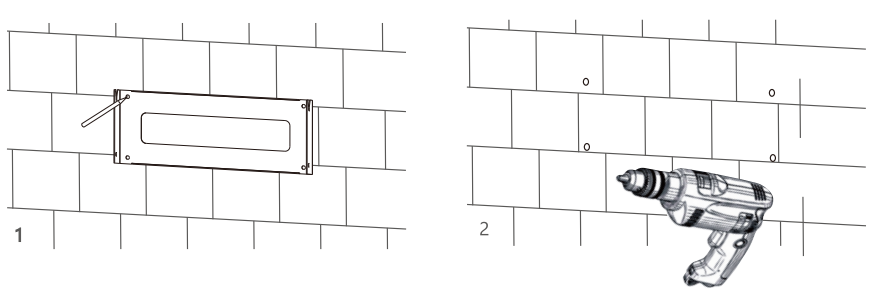

Step 2. Install and tighten the expansion bolts into the holes. Then use the corresponding nuts and washers (packaged together with the expansion bolts) to install and fix the wall-mounting bracket on the wall.

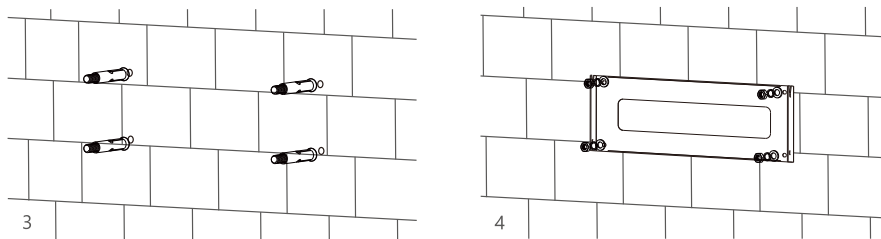

Step 3. Install the inverter on the wall-mounting bracket and lock the inverter using the security screws.

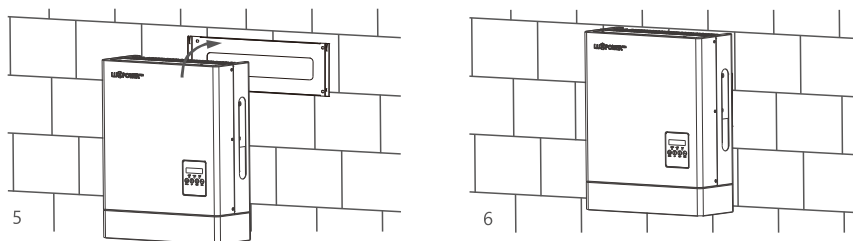

3.4 Connection

3.4.1 Connection Overview

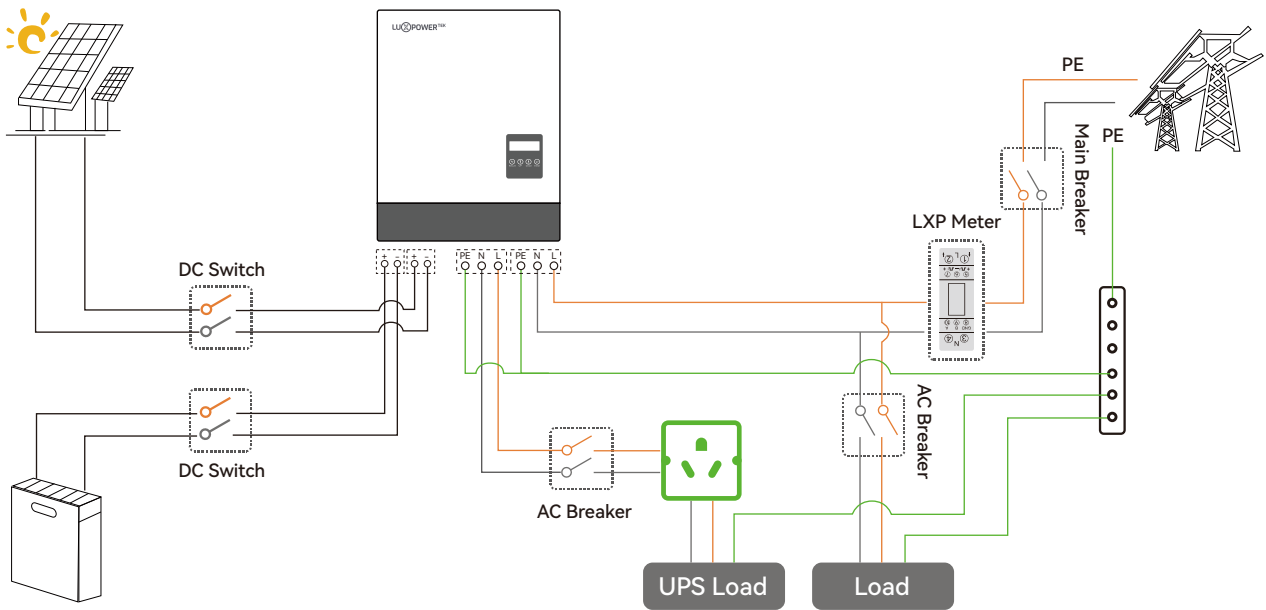

Please prepare the breakers before connection, breakers selection recommendation for both DC and AC

Hybrid	DC Breaker selection(2 poles)	AC Breaker selection(2 poles) AC Breaker with RCD	UPS Breaker selection(2 poles)
LXP 3K/3.6K/4K (MG)	100V/100A	40A/230Vac Type AC,>0.3A	32A/230Vac
LXP 4.6K/5K (MG)	100V/100A	50A/230Vac Type AC,>0.3A	32A/230Vac
LXP 6K (MG)	100V/100A	50A/230Vac Type AC,>0.3A	40A/230Vac
LXP 4K HB (MG)	500V/50A	50A/230Vac Type AC,>0.3A	50A/230Vac
LXP 5K HB (MG)	500V/50A	50A/230Vac Type AC,>0.3A	50A/230Vac
LXP 6K HB (MG)	500V/50A	50A/230Vac Type AC,>0.3A	50A/230Vac

Connection Terminals and Interfaces Overview

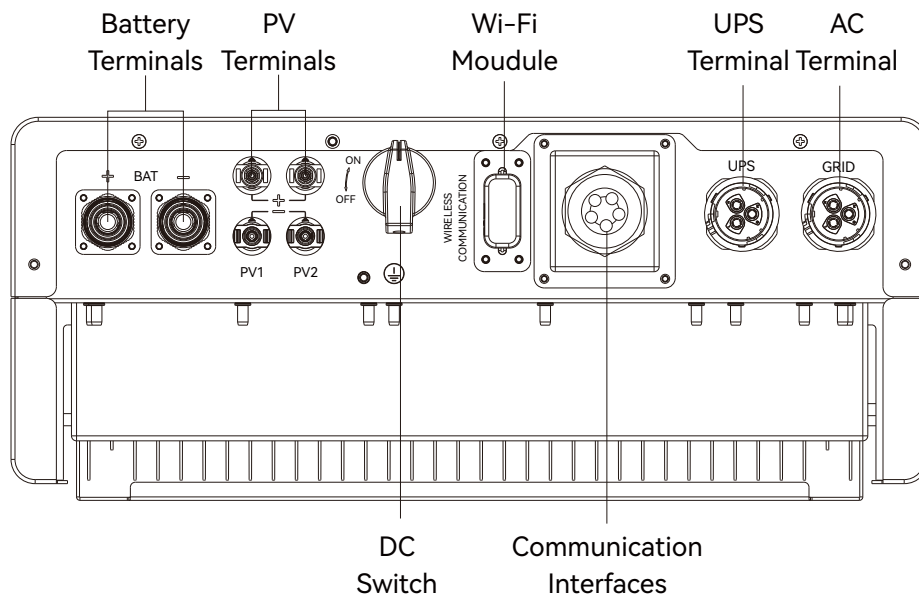

3.4.2 PV Connection

The PV connection of LXP hybrid inverter is the same to traditional on-grid solar inverter (string inverter)

NOTICE

- Before connection the PV, please use the multi-meter to measure the PV array voltage to verify if PV array is working normally, if not, please fix the PV array to normally working states before connection
- When your PV panel ambient temperature could possibly be lower than 0°C, then please check the PV array voltage up ceiling and if you are not sure please ask your system or panel provider for further assistance. As when temperature is extremely low the PV panel voltage will increase by a certain percentage.

Cable Requirement:

Cross-section	Cable Diameter	Minimum Voltage
3 - 6 mm ²	2-2.6mm	600V

Step 1. Turn off or disconnect the PV switch (DC switch). Then keep this switch always open during the connection.

Step 2. Assemble the PV connector

a) Strip 6~8mm insulation from the cable end.

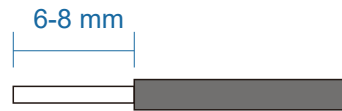

b) Assemble the cable ends to crimp contacts.

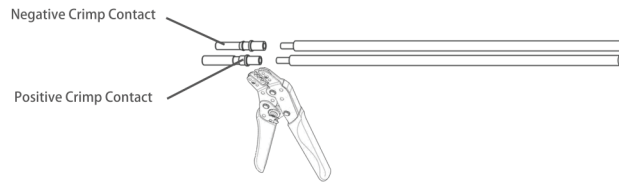

c) Lead the cable through the cable gland, then insert into the corresponding insulator until it snaps into place, then tighten the cable gland.

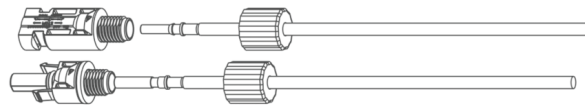

When verified the PV connector is tightly, align the 2 half connector and mate them together by hands until 'click' is felt or heard.

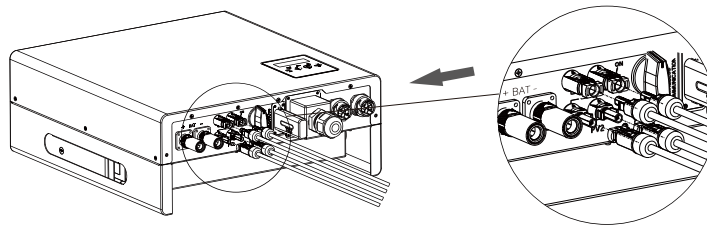

3.4.3 Battery Connection

This part in this manual only describe the battery connection on inverter side, should you need more detailed information regarding the battery connection on battery side please refer to the manual of the battery you are using.

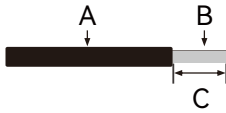
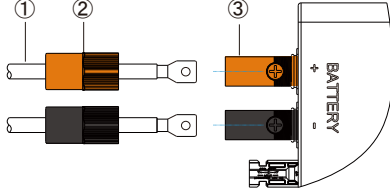
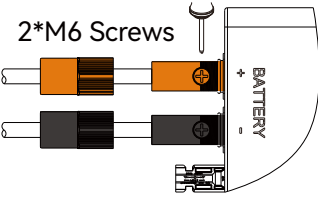
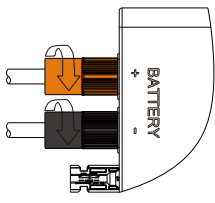
<p>Step 1. Assemble the terminal. battery connection</p>  <table border="1" data-bbox="335 694 694 840"> <tr> <td>A. Diameter</td> <td>10-12mm</td> </tr> <tr> <td>B. Cross Section</td> <td>20-25mm</td> </tr> <tr> <td>C. Strip Length</td> <td>-10mm</td> </tr> </table>	A. Diameter	10-12mm	B. Cross Section	20-25mm	C. Strip Length	-10mm	<p>① Cable ② Tighten Waterproof Sleeve ③ Terminals On Inverter</p> 
A. Diameter	10-12mm						
B. Cross Section	20-25mm						
C. Strip Length	-10mm						
<p>⊕ Red Cable ⊖ Black Cable</p> <p>2*M6 Screws</p>  <p>Warning! Polarity reverse will damage the inverter!</p>	<p>Recommendations Install a DC isolator between battery and inverter can avoid potential damages caused by electric arc.</p> 						

NOTICE

For the first time power on, please turn on the battery after LCD show "Run without Bat", otherwise the it may shorten the lifetime of inverter.
For lead acid batteries temperature sensor, please refer to Page29 "Cable Connection" figure.

Suggestions and Requirements

If the battery type is lithium-ion or ternary battery which need communication between the inverter and battery management system (BMS), the communication connection must be installed.

RJ45 Terminal Configuration of Battery Communication

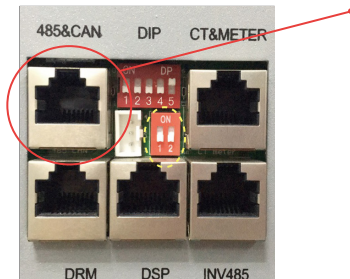

Red Color Switch	
Pin	Function Description
1	RS 485 B
2	RS 485 A
3	BAT CAN L
4	BAT CAN H
5	NC
6	BAT NTC
7	BAT Wake UP
8	GND-S

Blue Color Switch	
Pin	Function Description
1	RS 485 B
2	RS 485 A
3	NC
4	BAT CAN H
5	BAT CAN L
6	GND-S
7	NC
8	BAT NTC

Make the RJ45 terminal based on above introduction of each Pin definition, you could either make RS485 connector or CAN connector based on the best support connection way of your battery packs. For Lead acid battery temperature sensor, please connect signal to Pin6 and Pin8, the other pins are not connected. (External temperature sensor is needed, the sensor is 15KΩ thermistor for typical, or consult Luxpowertek)

● NOTICE

For Li-ion battery

1. If work with lithium battery, please make sure it is compatible with the Lux units. Now Lux Power inverter is compatible with Pylontech, Dyness, Aoboet, Weco, Murata, Merit 48V battery.
2. After battery power cable and communication cable connection, users need to choose battery brand by LCD.
3. The battery communication cable inside the Luxpower carton box is used for Pylontech battery, if you are using Pylontech battery, you can use the cable directly. Please note there is label 'BAT' (need to plug into battery side) attached with the cable, do not plug the battery side terminal to the inverter side.
4. If you install more than 8pcs Pylontech battery, you need a hub for the battery.
5. Please remember to connect Primary battery to inverter if you have battery group, and set the Primary battery for the battery group. (Please contact battery manufacture for battery group setup).

For Lead-acid battery

1. The lead acid battery temperature sensor cable is optional, if required, please request the temperature sensor cable from your supplier.
2. There are three stages for lead acid battery charge . For charge part, please set CV voltage and floating voltage. For discharge part, please set the discharge cut off voltage for on grid and off grid.

Connection between inverter and battery

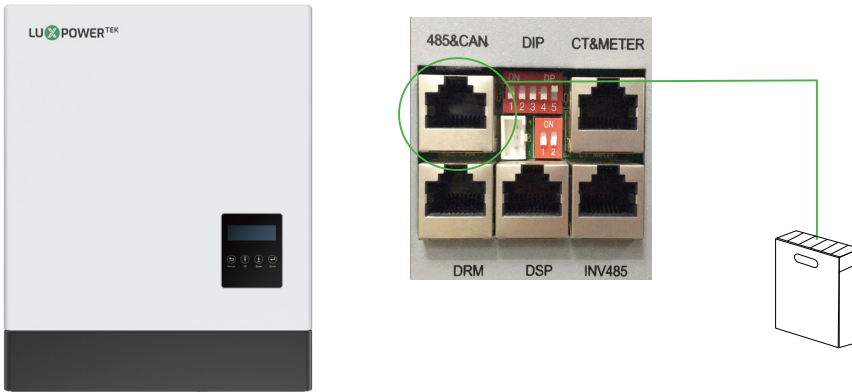

3.4.4 Grid Connection

Cable Requirements:

Cross-section	Diameter
4 - 6 mm ²	2 mm - 2.6 mm

Step 1. Assemble the AC connector.
AC Connector Structure Overview.

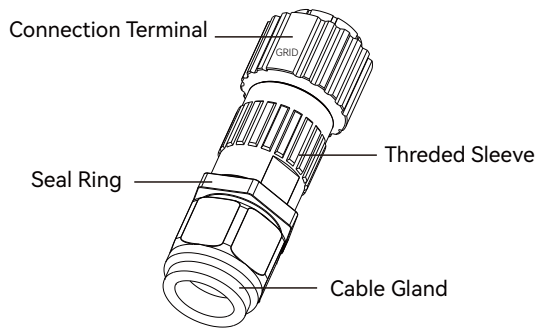

a) Lead the AC cable though cable gland, seal ring and threaded sleeve, and fully insert the conductors to corresponding terminals on connection terminal and tighten the screws.

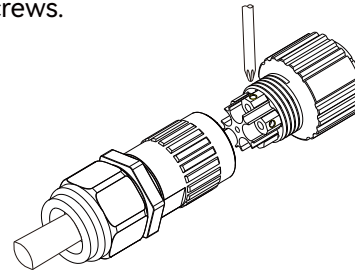

b) Refer to below figure and confirm the AC cables are correctly connected. The difference between the AC connector and UPS connector is that AC connector has a “Grid” mark on it and UPS does not.

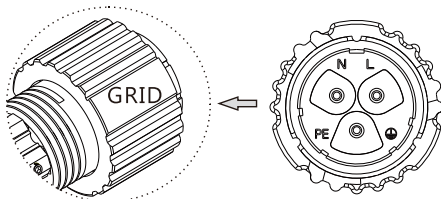

c) Assemble the GRID connector and make sure that the rib of the terminal block and the groove on the housing engage perfectly until a ‘click’ is heard or felt.

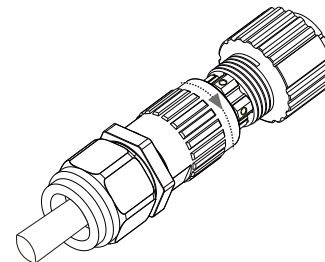

Step 2. Install the AC connector

- a) Align the GRID connector and AC terminal and mate them together by hand until a ‘click’ is heard or felt .
- b) An AC breaker (AC switch) should be installed between inverter and the grid, confirm the AC breaker is working normally before connect the AC cable from inverter to AC breaker. Turn off the AC breaker and keep it open.
- c) Connect the PE conductor to grounding electrode, and connect N and L conductors to AC breakers.
- d) Connect the AC breakers to the AC grid.
- e) You must install a separate single-phase circuit-breaker or other load disconnection unit for each inverter in order to ensure that the inverter can be safely disconnected under load.

● NOTICE

The inverter has the function of detecting residual current and protecting the inverter against residual current. If your inverter has to equip a AC breaker which has the function of detecting residual current, you must choose a AC breaker with the rating residual current more than 300mA.

3.4.5 UPS/Back-up Connection

Cable Requirements:

Cross-section	Diameter
4 - 6 mm ²	2 mm - 2.6 mm

Step 1. Assemble and install the UPS connector process is the same as AC connectors which show in Chapter 5.4 Grid Connection (the Step 1 and Step 2). Finish the UPS connector assembling and installation first of all.

Step 2. UPS wiring.

There are 2 different UPS wiring mode in accordance with different local or national rules, standards or regulations. Please choose the suitable wiring mode according to the local requirements.

Mode A: Neutral line of alternative supply must not be isolated or switched.

The connection diagram of UPS Connection Mode A is shown in below figure.

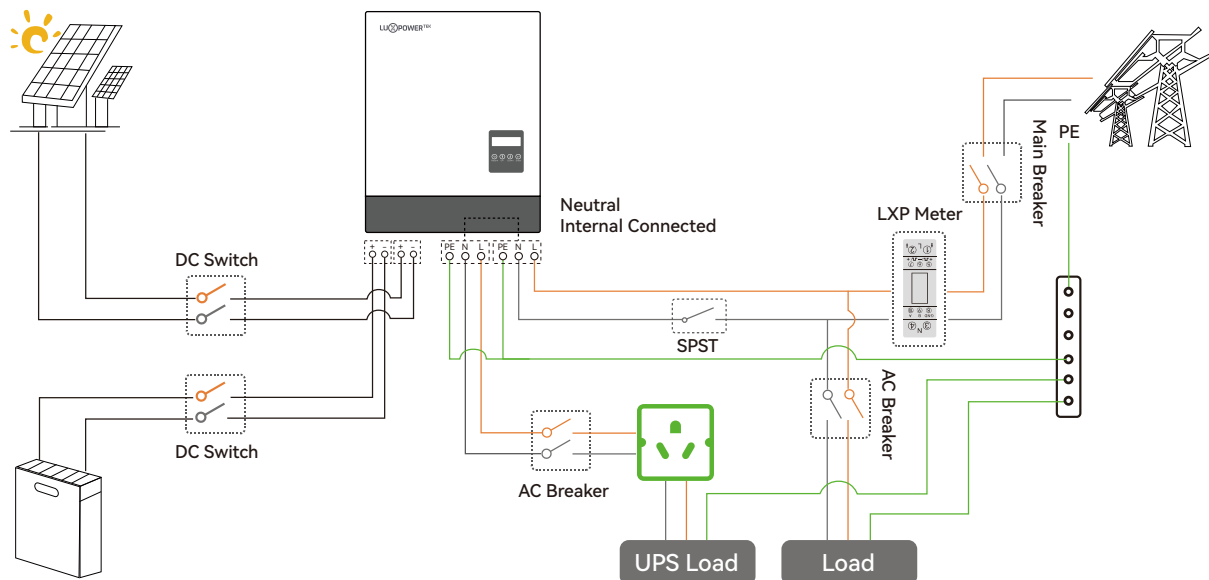

NOTICE
 Backup loads neutral and grid neutral are connected internally inside the inverter, so the installer do not need to connect them outside. The power of backup load should be lower than 5kW.

Mode B: Neutral line of alternative supply can be isolated or switched. The connection diagram of UPS Connection Mode B is shown in below figure.

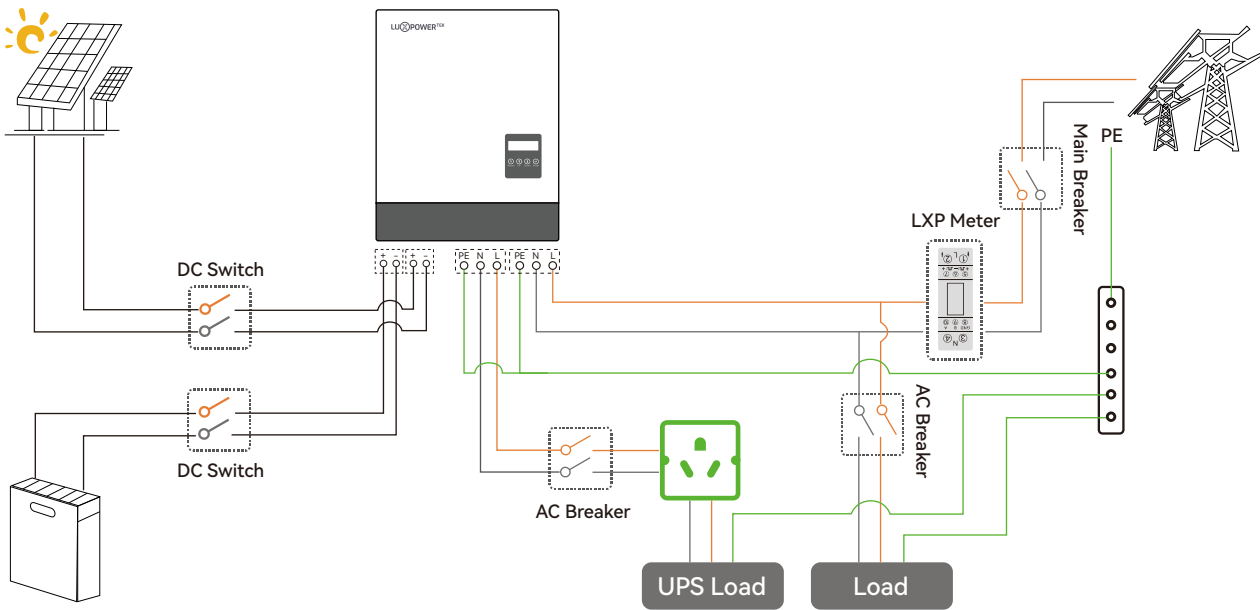

3.4.6 Meter and CT Connection

In a completed installed on-grid energy storage system, the CT or Meter should be installed. The CT or Meter should installed in the right position as below picture.

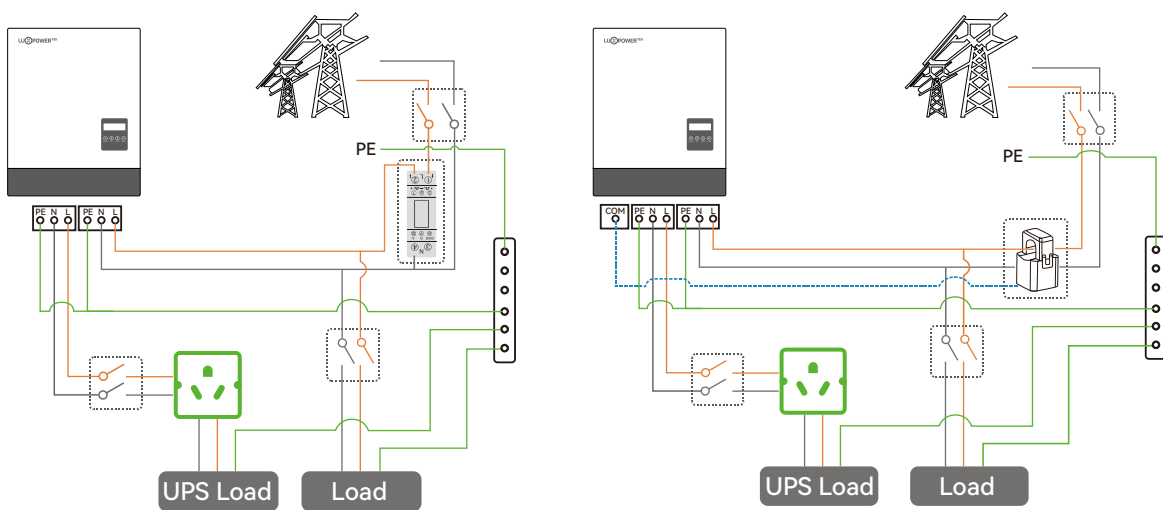

The communication port for communicate with meter or CT clamp is as below:

RJ45 Terminal Configuration of Meter/CT Communication

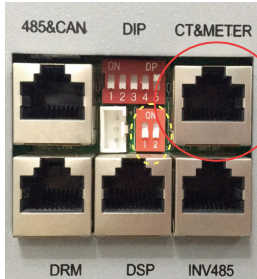

Red Color Switch	
Pin	Function Description
1	Meter RS485-B
2	Meter RS485-A
3	NC
4	NC
5	CT1 N
6	CT1 P
7	CT2 N
8	CT2 P

Bule Color Switch	
Pin	Function Description
1	Meter RS485-B
2	Meter RS485-A
3	Debugging RS485-B
4	Debugging RS485-A
5	CT1 N
6	CT1 P
7	CT2 N
8	CT2 P

3.4.6.1 Connect the Meter

The functional interfaces overview of the meter is shown in below figure. Now Luxpower only support EASTRON SDM120 and SDM630- Modbus Modbus model meter.

Step 1. Connect the meter in the LN line as below

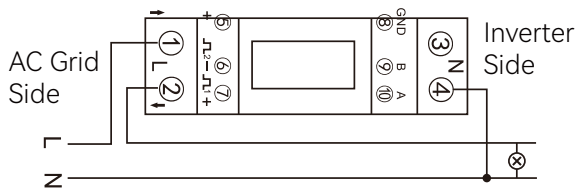

Step 2. Connect the communication cable between inverter and meter, and plug the RJ45 to communication port

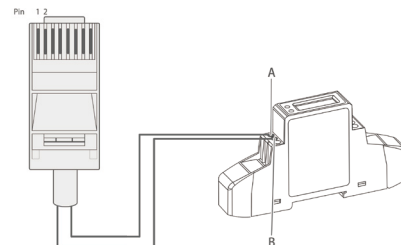

Step 3. Check the connection. When the meter displays -xxxxW as below figure shows, the hybrid inverter is feeding power to the grid. And when it displays xxxxW, it means the house load is using energy from grid.

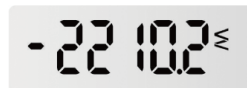

3.4.6.2 Connect the CT

For the CT clamp connection, we need to put the CT clamp in the L cable and the arrow printed on the CT should point to inverter.

Now Luxpower support two ratio **1000:1** and **3000:1** CT clamps . For default, the ratio is **1000:1**, if you install another CT clamp, please set it in the monitor system or LCD.

For the CT clamp cable, users can use the normal net cable to extend the length if the original length is not enough. The longest distance can be 100m.

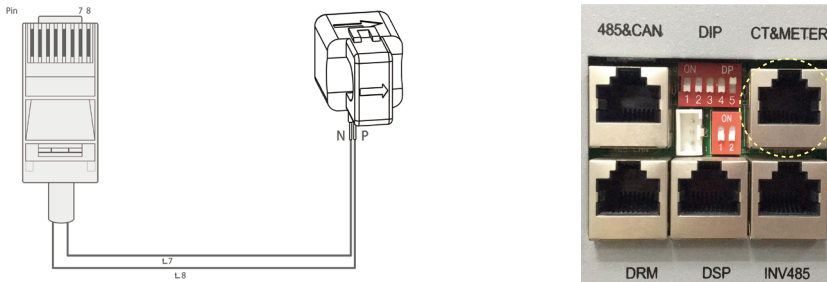

3.4.7 Communication Connection

Interface Overview

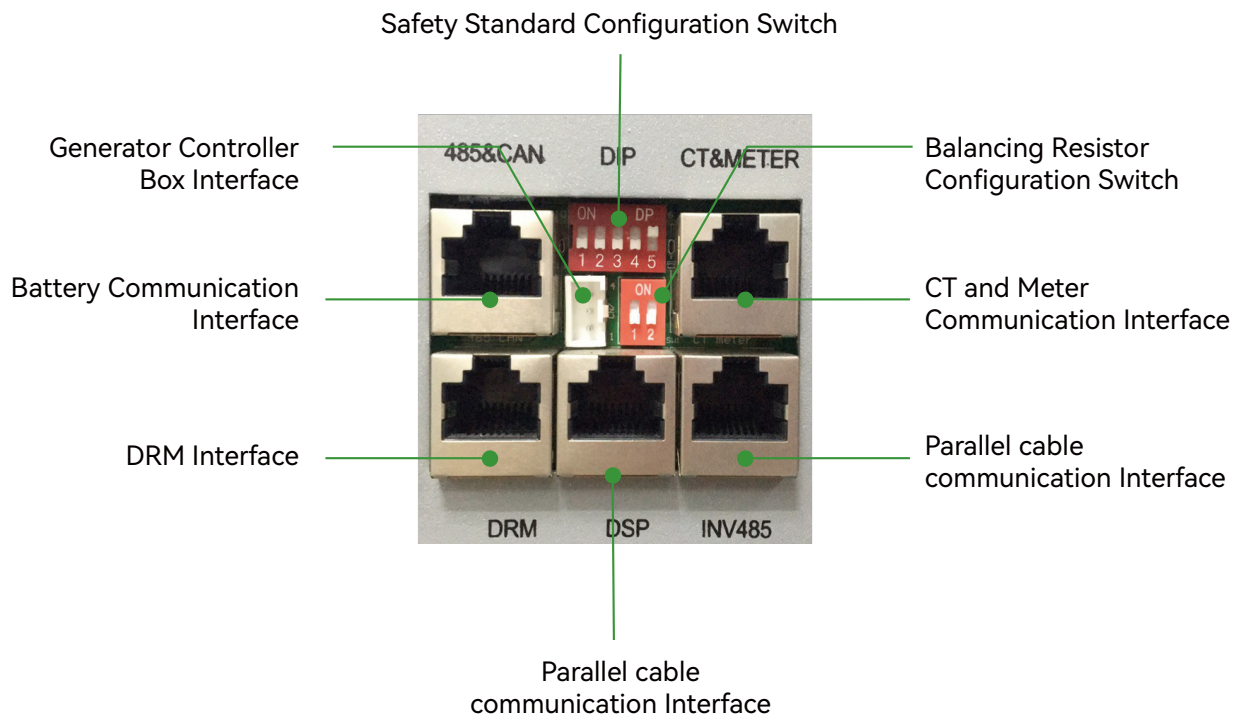

3.4.7.1 DRMs Connection

DRMs is short for ‘inverter demand response modes’, and it is a mandatory requirements for inverters in Australia

DRM Communication Interface Overview



RJ45 Terminal Configuration of DRM

Pin	Function Description
1	DRM15
2	DRM26
3	DRM37
4	DRM48
5	RefGen
6	DRM0
7	+12V
8	GND-S

3.4.7.2 Safety Standard Configuration - SW2

By configuring the DIP switch the inverter could comply with different safety requirements of various areas.

Sw2 Safety Standard Configuration Switch Overview

Note: The DIP switch is composed of five-digit binary number PINs. Each PIN has two status, when set upward to“ON”, its value turns to“1”, when set downward, its value turns to “0”.

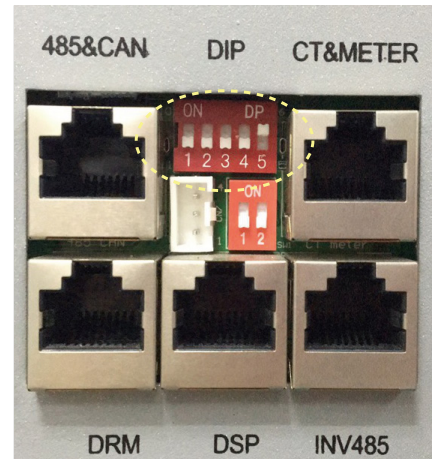

Safety Standard Configuration Guidance

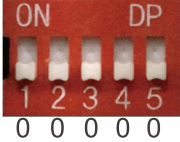
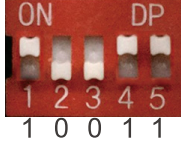
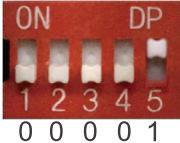
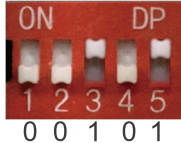
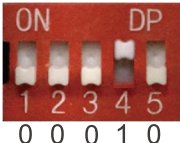
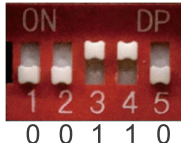
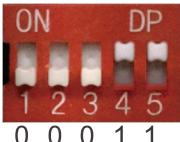
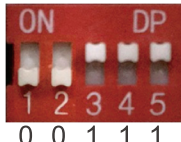
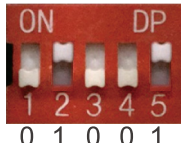
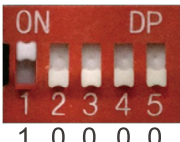
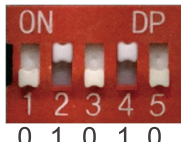
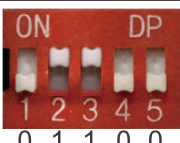
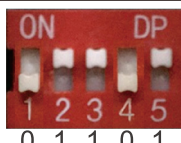
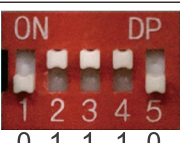
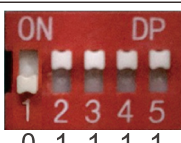
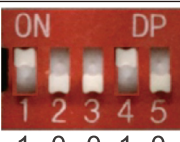
Country Standard	SW2 Configuration	Country Standard	SW2 Configuration
Default VDE0126		En50549	
Germany VDE0126		United Kingdom G99	
Australia AS4777		United Kingdom G98	
New Zealand NZS		Germany N4105	
Italy CEIO-21		Europe EN50438	
South Africa NRS 097-2-1		Finland EN 50438	
Thailand PEA		Thailand MEA	
Ireland EN 50438		Czech EN 50438	
CEIO-21 ARET			

3.4.7.3 Balancing Resistor Configuration - SW1

By configuring the SW1 balancing resistor configuration switch, you could configure the balancing resistors of parallel CAN communication. This Function is used for multiple inverter paralleling operation. Please turn on the DIP in the first and last inverter in the inverter loop. For more info, please check the parallel connection part.

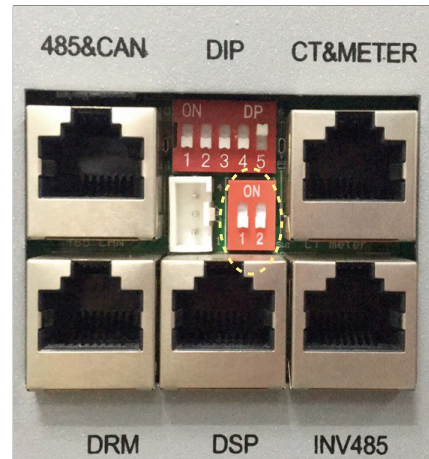

3.4.7.4 Wireless Communication Module Connection

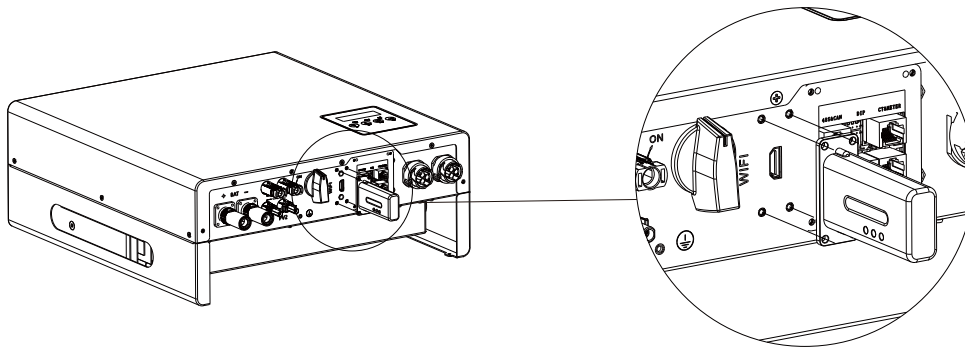

The Wireless Communication Interface Details

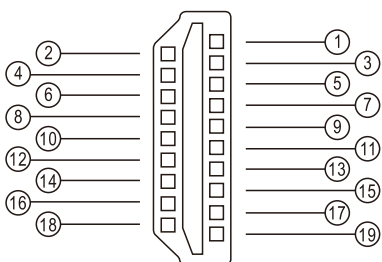

Pin	Function Description
1 & 2	VCC
3 & 4	GND
5	RS485-A
6	RS485-B
Others	Reserved

3.4.8 Grounding

A second protective earth (PE) terminal is equipped at the side of the inverter.

Be sure to connect this PE terminal to the PE bar for reliable grounding.

Cable Requirements

3-6mm² copper cable or 10-16mm² aluminum cable.

NOTICE

Install the Protective Shell

When you finish all of above chapters of connections, please don't forget to install the protective shell back to the inverter. This step can be carried out either after finished grounding or commissioning of the system.

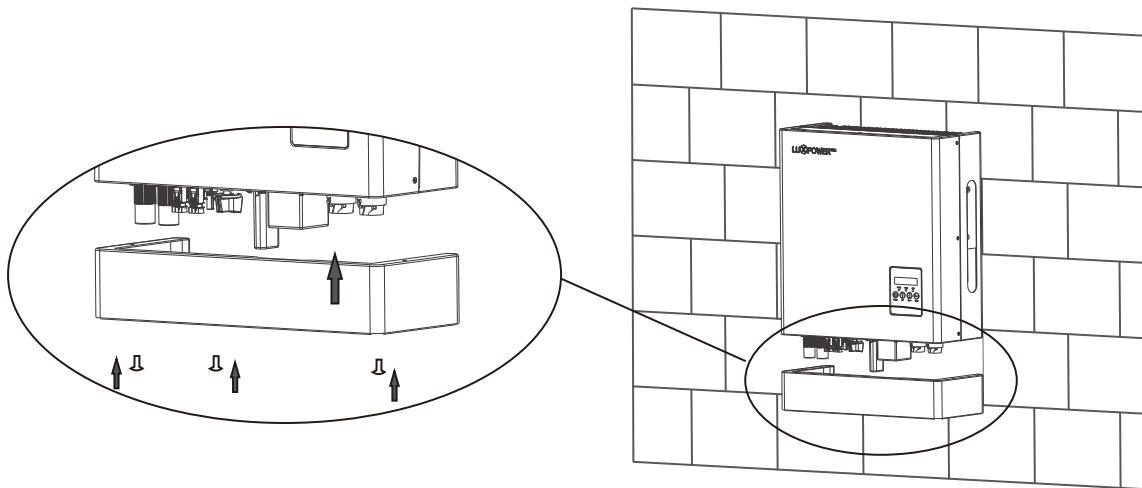

4. Operation Guide

4.1 Operation Mode

Users can have different settings to satisfy their demands, the working modes is as below:

Operation mode	Explanation	Related Settings	Application Notes
Self usage (Default mode)	The priority of the PV energy will be Load > battery > grid, which means the energy generated by PV will be mainly used by local loads, and rest will be stored in the battery, excessive power will be feed back into the grid.	Effective when charge priority and force time charge/discharge are disable	Increase the self consumption rate and reduce the energy bil significantly
Charge priority	The priority of the PV energy will be battery >Load >grid, which means the energy generated by PV will be used to charge the battery first, and then used by local loads, excessive power will be feed back into the grid.	Charge Priority and related time, SOC	When the load shedding always happens, users need to charge battery first
Force time	User can set the charging and discharging time and priority of energy use under Force Time Use mode. This is also used to flexibly make use of your system by customized settings by the users.	Force charge/discharge enable and disable, and related time SOC	This mode suits for situation where the price difference of energy is big under Time of Use (To U)
Micro Grid mode(Genset)	When used in pure off grid application, users may connect the Gen set output to grid input, when battery SOC is low. Inverter will use generator to take the load and charge the battery.	Micro grid enable /disable	Area where is no grid and there is no utility
Off grid mode	Inverter will switch to off grid mode automatically when there is no grid.	UPS enable	Area where is no grid

4.2 LCD operation and settings

4.2.1 LCD Menu Structure Overview

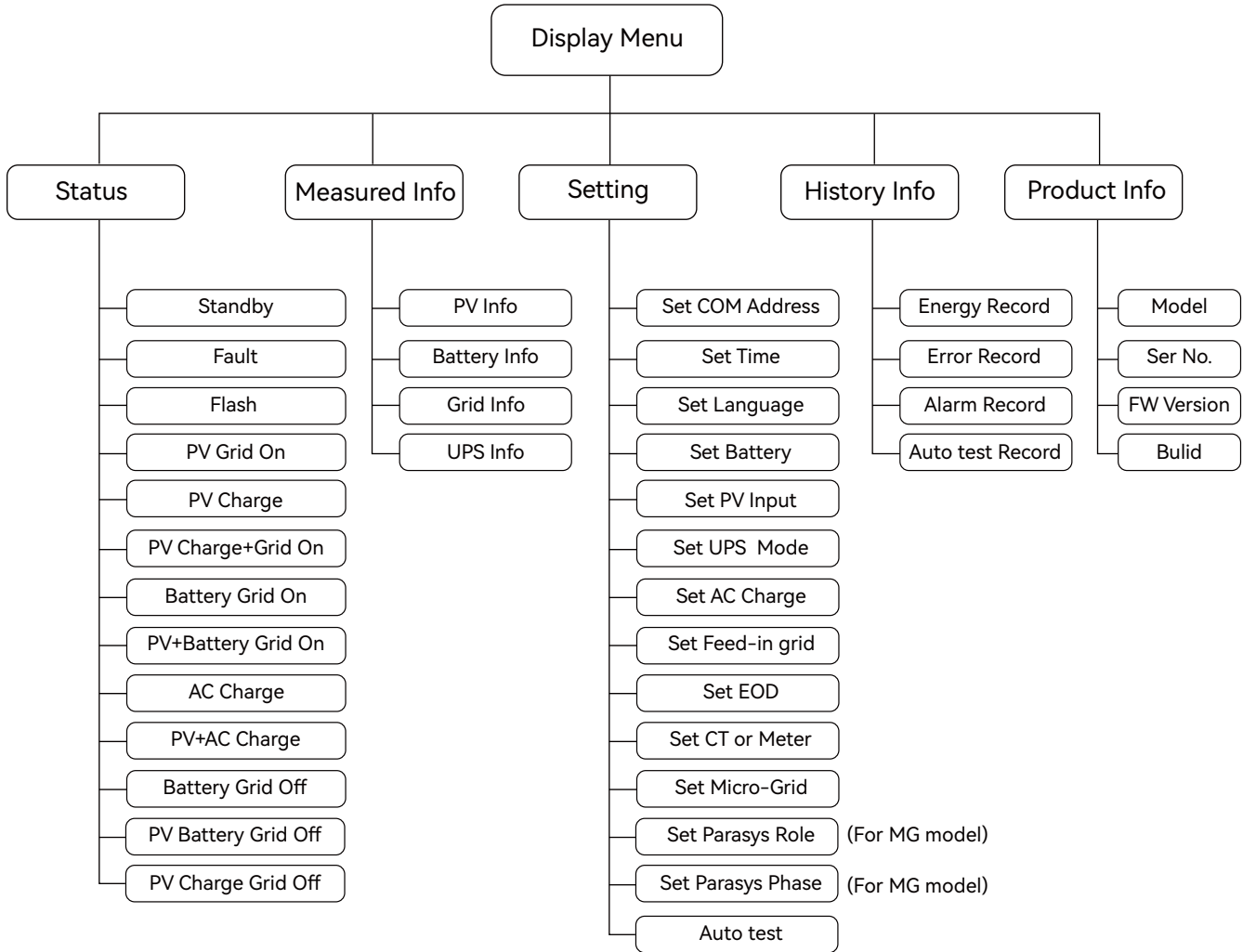

4.2.2 Status and Parameter show in LCD

a) Standby

Inverter is waiting for sufficient DC voltage from the PV or battery. It occurs when the sunlight is not sufficient to make the inverter working and battery SOC is low.

b) Fault

Fault occurred with the inverter or system. Inverter will stop working unless fault or error is fixed. Detailed information and troubleshooting please refer to Chapter 8. Troubleshooting&Maintenance.

c) Flash

When upgrading the firmware of inverter, the inverter will working at flash status.

There are 2 ways to upgrade the firmware of inverter:

- Remote upgrading based on remotely connected server through the wireless communication module.
- Locally upgrading through RS485 communication connection.

d) PV Grid On

The inverter is working normally on-grid, and the all the power generated by PV will export or feed-in via the AC grid connection to your general loads and the grid.

e) PV Charge

The inverter is working normally, the power generated by PV is within a range that all the PV power is used to charge the battery, while there are no excessive power rested to output from neither the AC Grid connection nor UPS connection.

f) PV Charge+Grid On

The inverter is working normally on-grid, the power generated by PV is sufficient and within a range which PV power is used to charge the battery and there are still excessive PV power rested to export or feed-in via the AC grid connection. Under this inverter working status, your general loads will either consumption the power from PV or use power from the grid or at them same time from the two sources, the detailed situation is based on the PV power output range and your general loads power demands differences.

g) Battery Grid On

The inverter is working on-grid with no PV power input, and there are sufficient energy stored in the battery, the inverter is discharging the battery and export the power via AC grid connection to your system.

h) PV+Battery Grid On

The inverter is working normally on-grid with limited PV power input and the battery energy is sufficient, at this inverter working status the limited PV power is used together with the battery discharging power to export or feed-in via the AC grid connection.

l) AC Charge

The inverter is working normally on-grid with no PV input power, and is using the AC power from the grid to charge the battery as configured previously (the function should be enabled firstly as Chapter Inverter Settings - h) AC Charge Settings described).

j) PV+AC Charge

The inverter is working normally on-grid with limited PV input power, and the batter SOC is not sufficient, if at this time the inverter is configured to charge the battery with both PV power and AC grid power, then inverter will run in this status.

k) Battery Grid Off

The inverter is working normally off-grid with no PV input power, and the battery SOC is sufficient. When inverter works at this status, the battery is discharging to output power via the UPS connection.

l) PV Battery Grid Off

The inverter is working normally off-grid with limited PV input power, and the battery SOC is sufficient. When inverter works at this status, the battery is discharging together with the PV power to output via the UPS connection.

m) PV Charge Grid Off

The inverter is working normally off-grid with sufficient PV input power, and the battery SOC is insufficient. When inverter works at this status, the inverter is charging the battery using PV power and there are excessive power rested to output via the UPS connection.

Parameter Explanation of LCD Displays

Parameters of Power:

Ppv: PV input power

Sac: apparent power of AC output

So: Apparent power of UPS

Pd: discharging power

Pac: active power of AC output

Po: active power of UPS

Pc: Charging power

PtoGrid: active power of exporting / feed-in to grid

Parameters of Voltage and Frequency etc.:

Vb: battery voltage

Vbus: voltage of DC bus

F: frequency

Vo: UPS voltage

Vg: grid voltage

SOC: state of charge

Parameters of Energy:

Einvday: energy output via AC output today

Ecday: charged energy today

Edday: discharged energy today

Eoday: UPS output energy today

Epv1day: energy generated today of PV array 1

Epv1all: total energy generated of PV array 1

Erecday: AC charge energy of today

EtoUday: energy consumed by loads today

EtoGday: feed-in energy today

Einvall: total energy output via AC output

Ecall: total charged energy

Edall: total discharged energy

Eoall: total UPS output energy

Epv2day: energy generated today of PV array 2

Epv2all: total energy generated of PV array 2

Erecall: total AC charge energy

EtoUall: total energy consumed by loads

EtoGall: total feed-in energy

4.2.3 LCD Settings

4.2.3.1 Information Searching

Refer to below flow chart which shows the information option interfaces and interconnection.

Operator can search target information by following below directions.

a) Enter into Display Menu Interface

Touch Return button to enter Display Menu interface, search and select corresponding information options using Up and Down button, relevant information will be immediately displayed on the LCD screen after touched Enter button to confirm the selection.

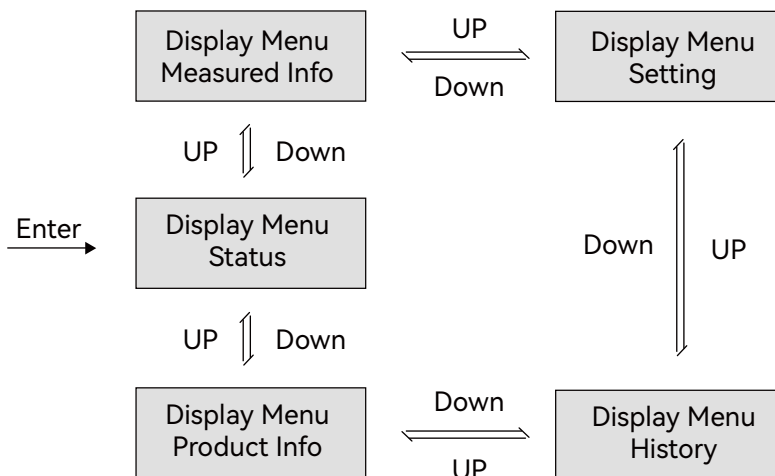

b) Search History Information

In Display Menu interface, select History menu and touch Enter button to enter in the History menu interface and use Up and Down button to select relevant display menu and touch Enter button to view detailed history information.

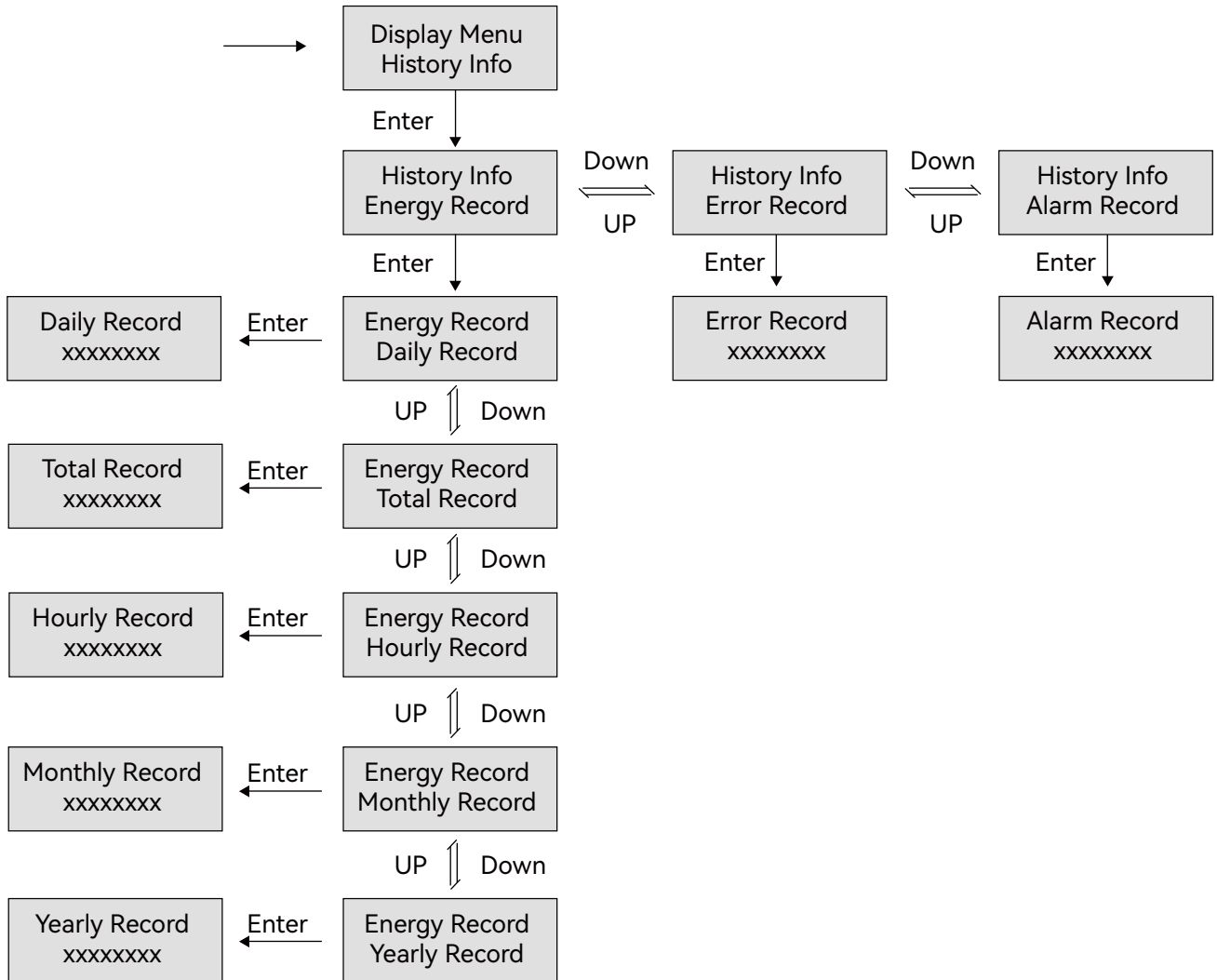

c) Search Product Information

In Display Menu interface, select Product Info. menu and touch Enter button to enter in the Product Info. menu interface to view detailed product information.

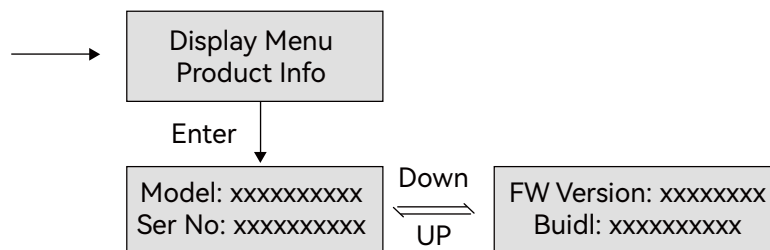

d) Search Measured information

In Display Menu interface, select Measured Info. menu and touch Enter button to enter in the Measured Info. menu interface to view detailed running information of the system, such as PV, battery, grid and UPS data.

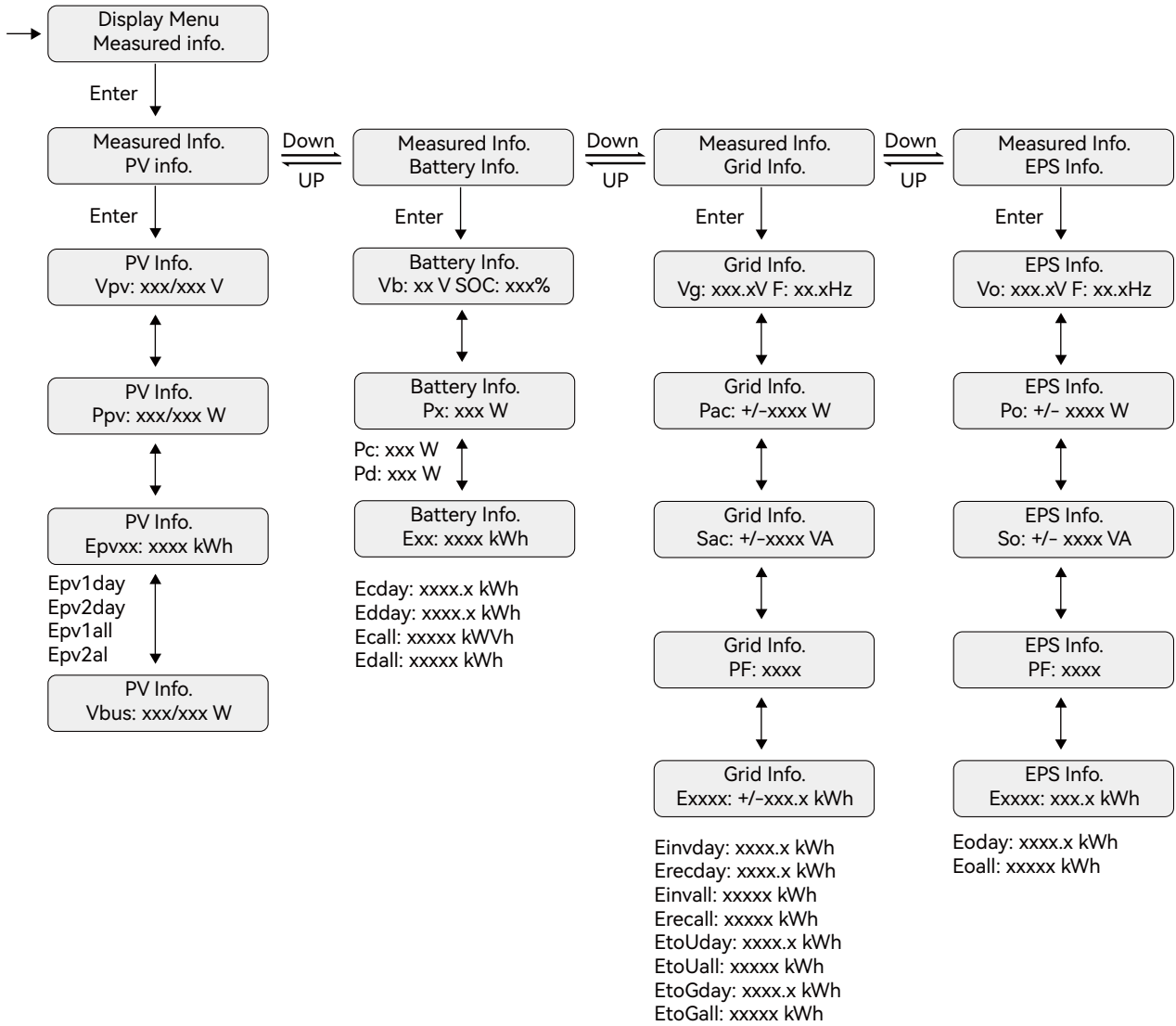

4.2.3.2 Settings Guidance

a) Enter Into Setting Interface

Touch Return button to enter into Display Menu interface, search and select the Setting menu using UP and Down button, and then touch Enter button to confirm and enter into inverter setting interface.

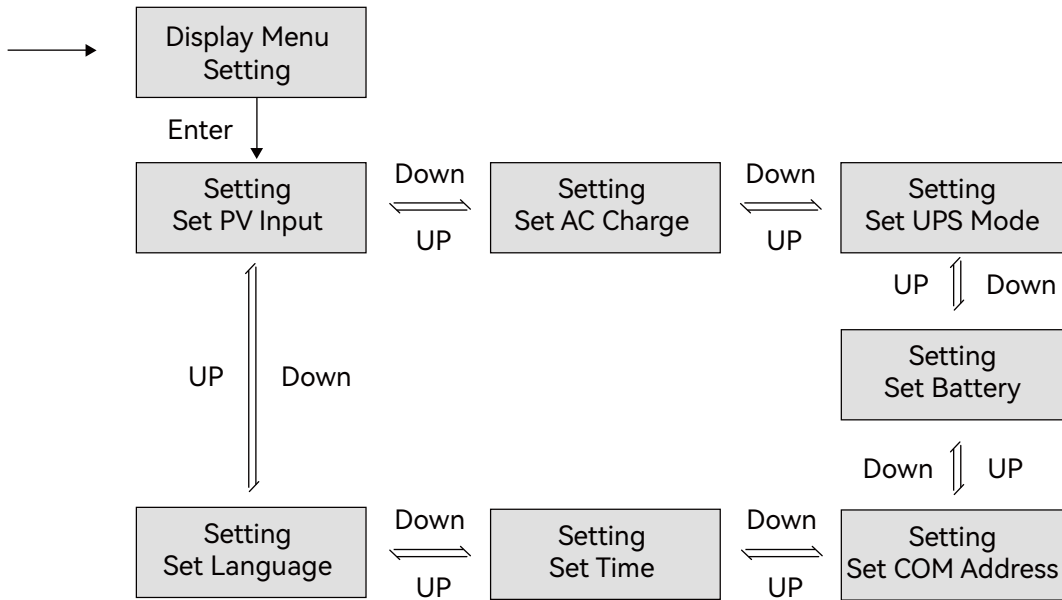

b) Language Setting

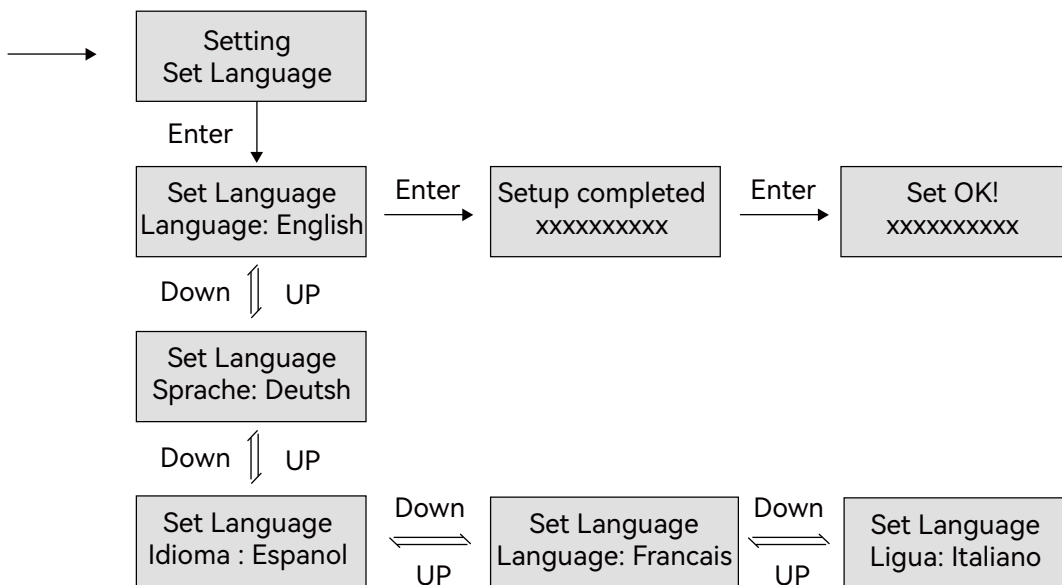

c) Communication Address Settings

Notice that the setting range of the RS485 communication address is from 000 to 255, and it's set to be 001 by default when manufactured.

Operating Guidance: by touching Enter button to select the numerical digits of the COM address - hundreds, tens and units, and use UP and Down button to set the number of selected numerical digits.

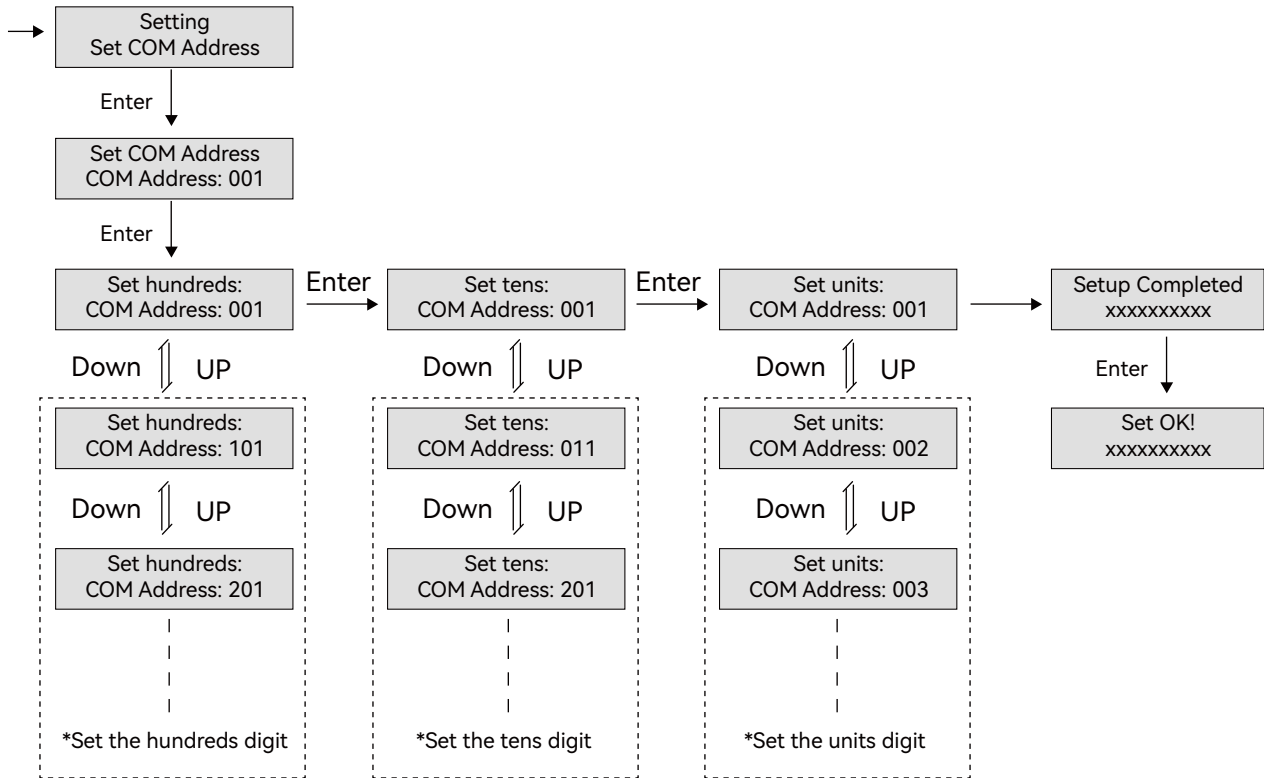

d) Battery Settings

In Setting interface, search and select the Set Battery menu and touch Enter button to confirm and enter into battery setting interface. Set the battery parameters and configuration follow the direction in below flow chart. Notice that the LXP Hybrid series energy storage inverter supports Lithium-ion and Lead-Acid type batteries.

Operating Guidance: by touching Enter button to select the options and use UP and Down button to set the parameter or number of selected options.

e) Time Settings

In Setting interface, search and select Set Time menu then enter into time setting interface. Follow the direction in below flow chart to set the time parameters.

Operating Guidance: by touching Enter button to select the numerical digits of the time - year, month, date, hour and minute, and use UP and Down button to set the number of selected numerical digits.

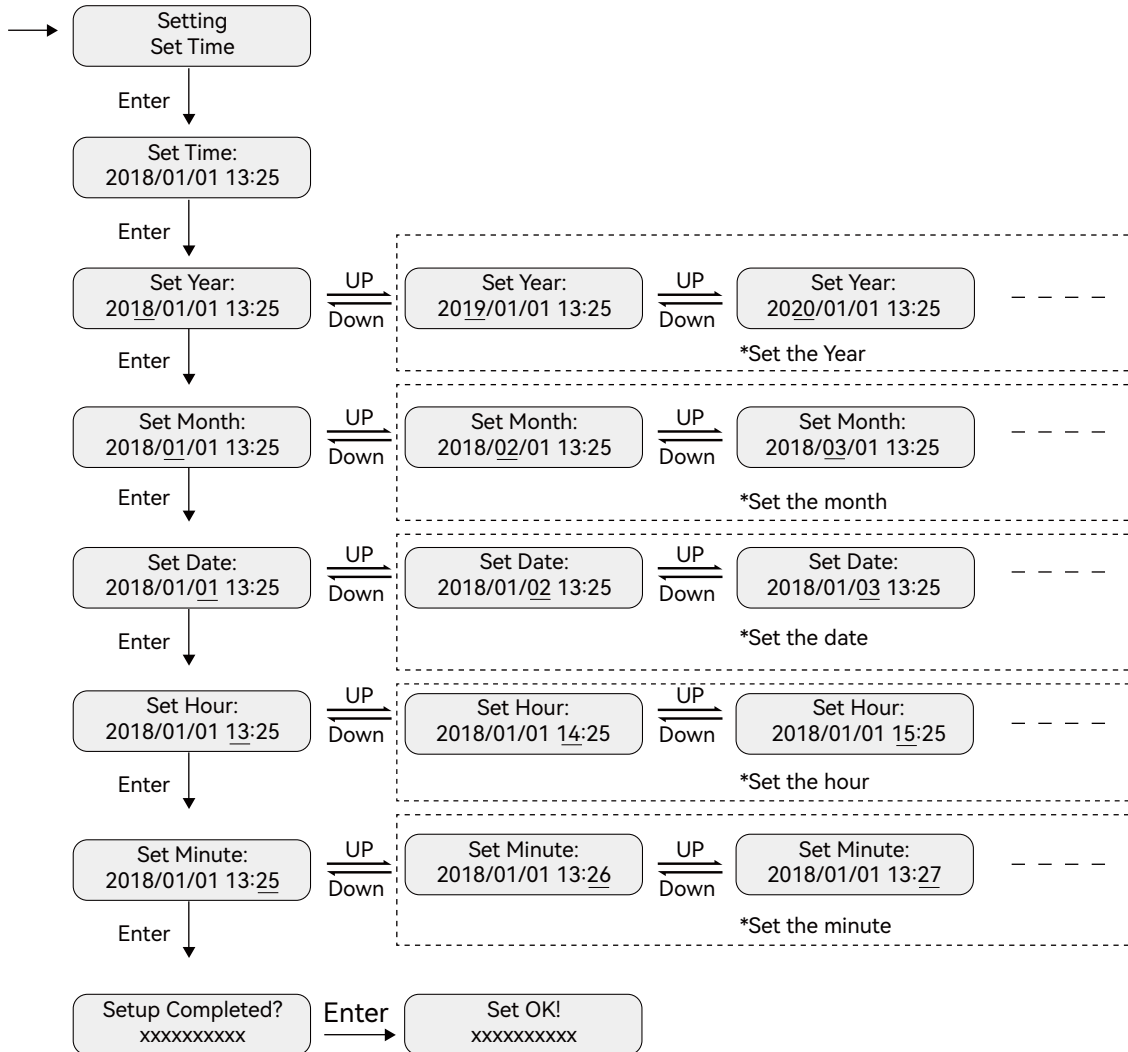

f) PV Input Settings

Operating Guidance: by touching UP and Down button to select the parameter of the PV input. Notice that the PV input parameters must be set in accordance to actually configuration of PV system. The parameter is set to Two PV separate by default.

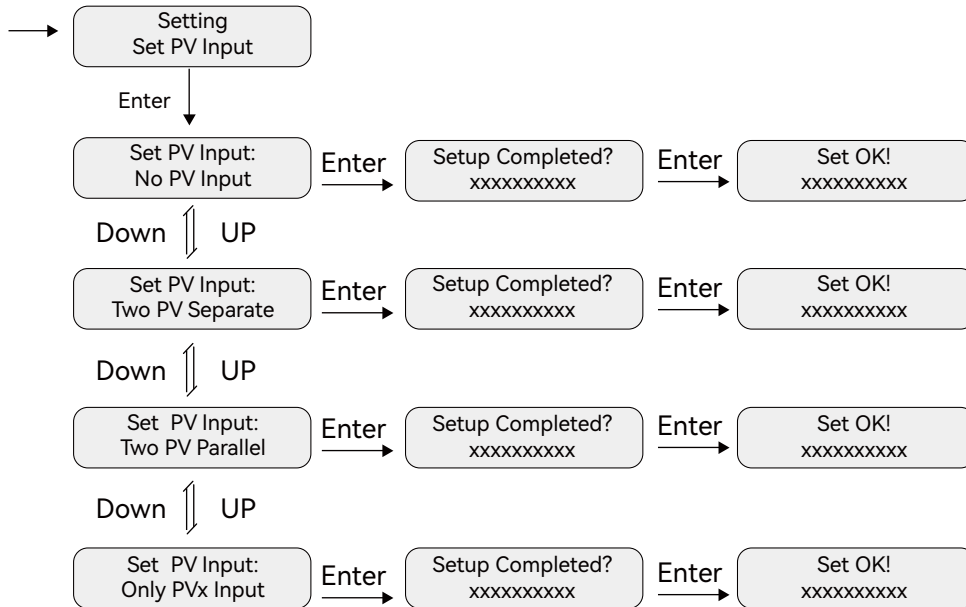

g) UPS Settings

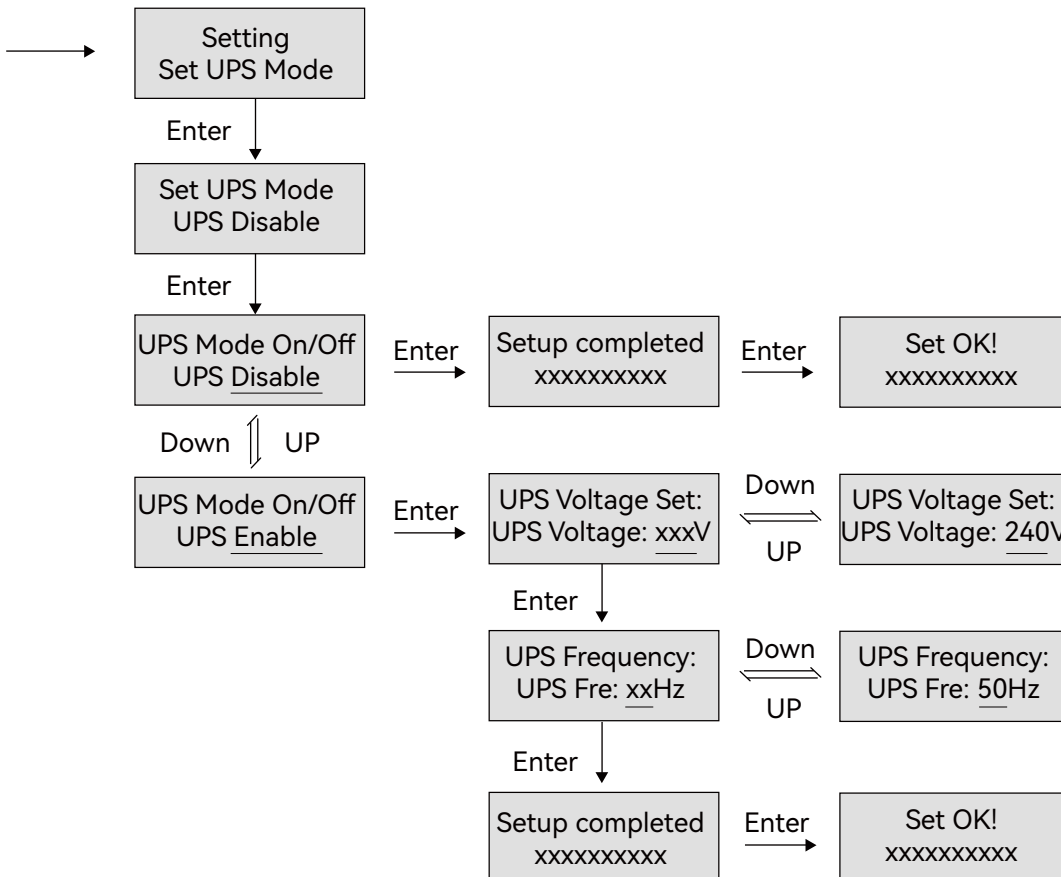

h) AC Charge Settings

In Setting interface, search and select the Set AC Charge menu and enter into AC charge setting interface. Follow the directions in below flow charge to enable or disable AC charge function, if enabled then configure relevant parameters.

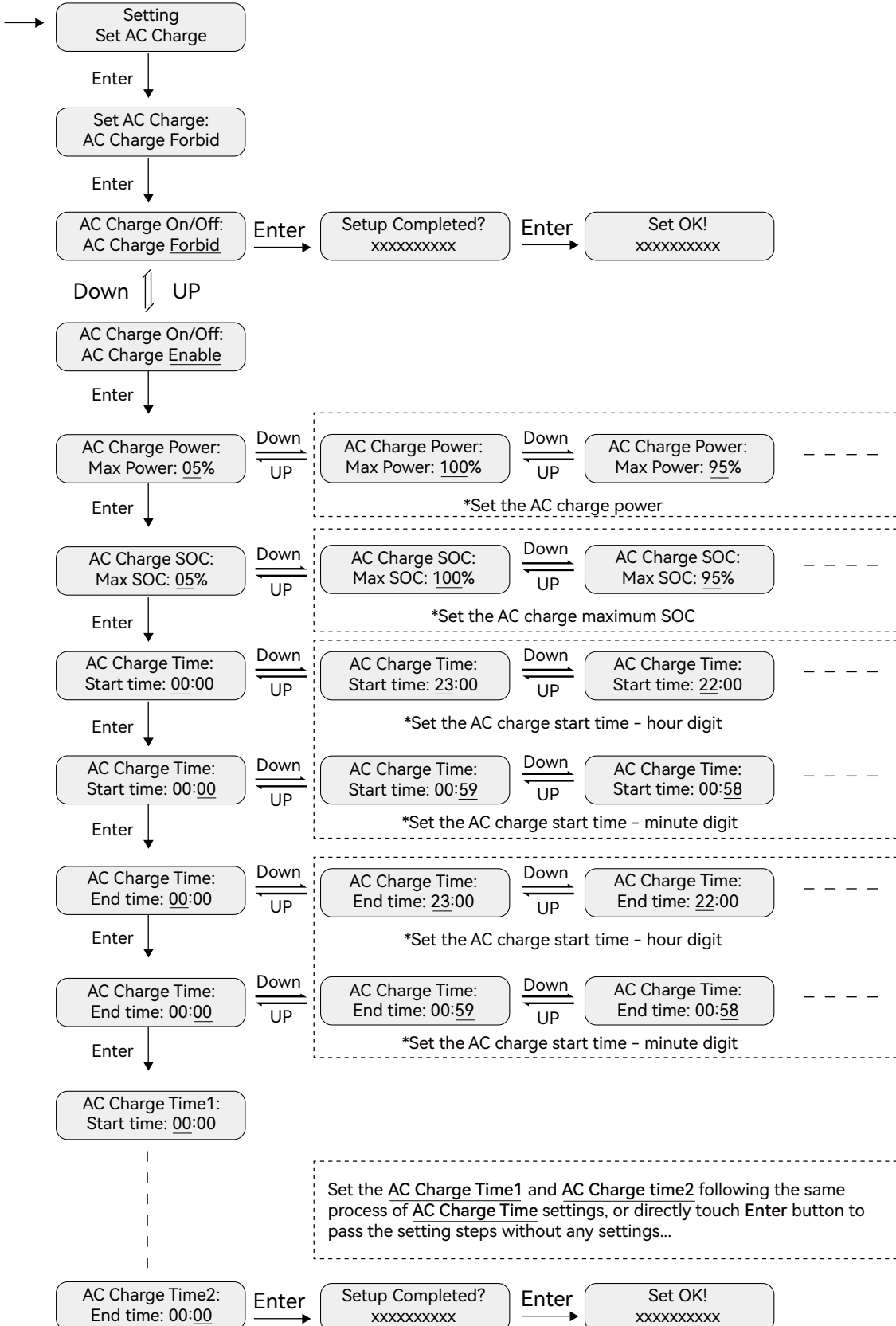

i) Feed-in grid Settings

Since in some countries, users can not feed energy into grid, so they are able to disable energy export function in the LCD, or set power percent which can feed into grid.

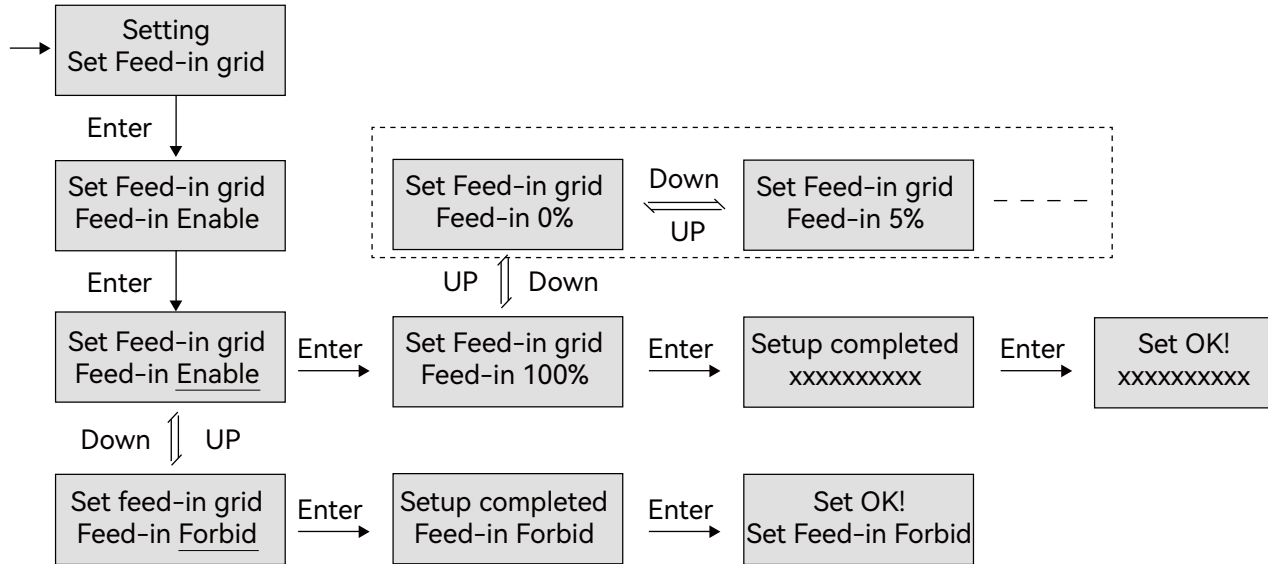

j) EOD Settings

Users are able to set end of discharge (stop discharging) battery level when there is grid. This setting is important for some area where always has load sheddings.

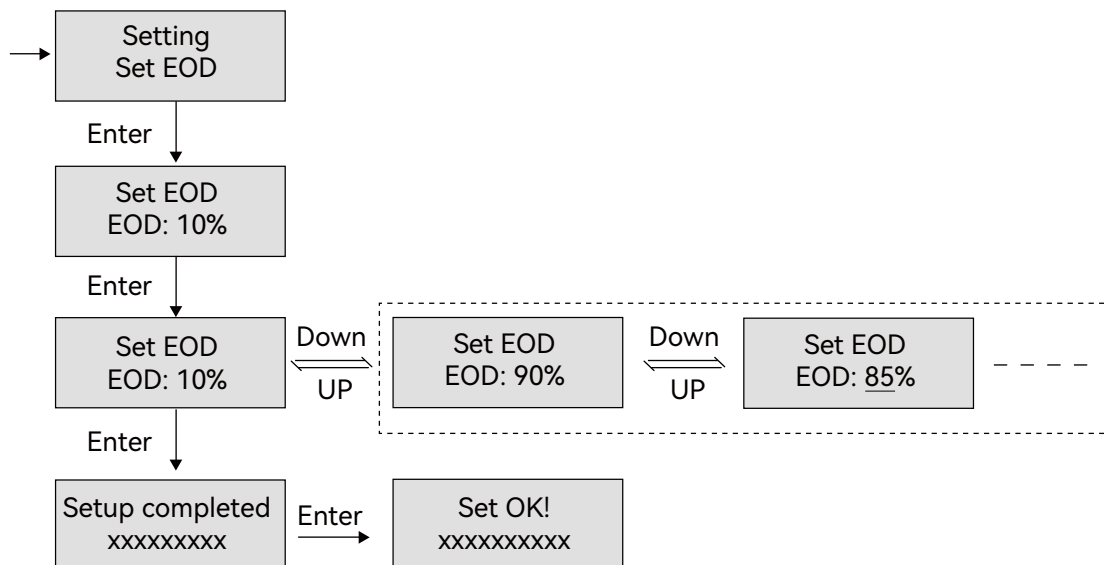

k) CT or Meter Setting

Since the inverter support the connection of both CT clamp and meter, users can select if the system is connecting a meter or a CT clamp and then choose the CT clamp ratio when connects a CT clamp.

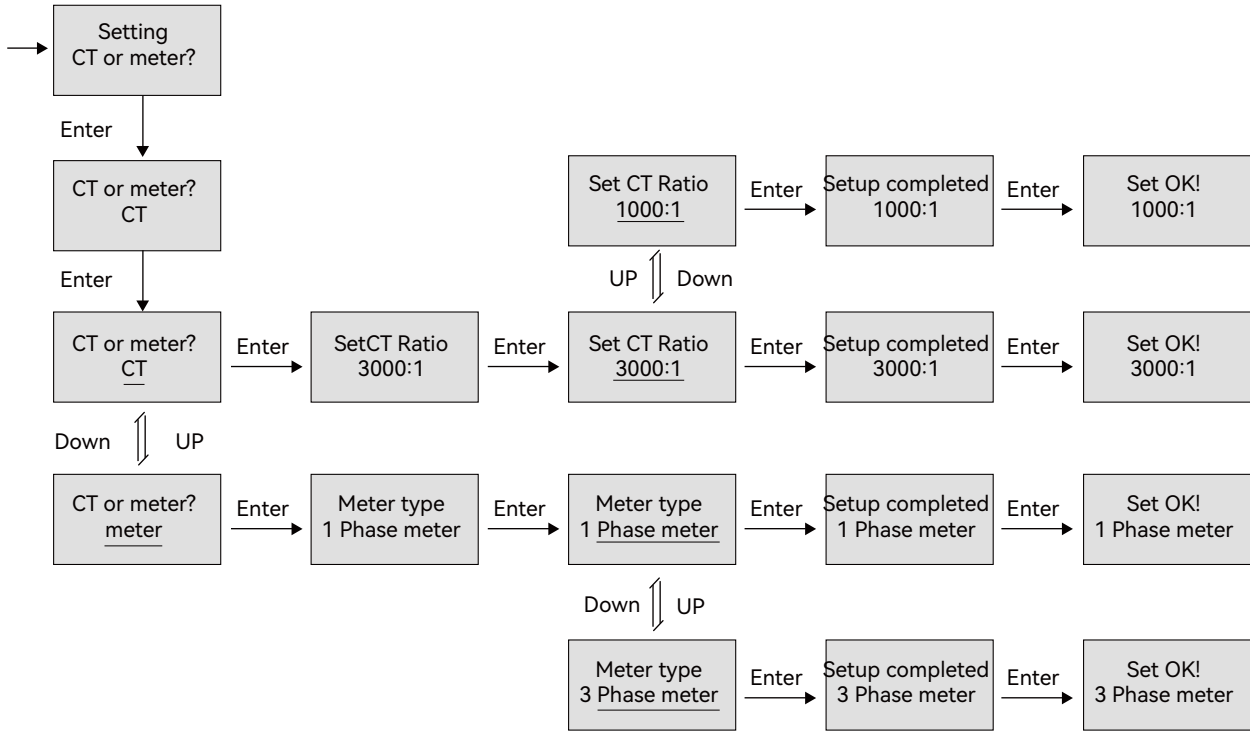

l) Micro-Grid Setting

When connect the generator to inverter AC terminal, users need to enable mirco grid function so the inverter will use generator to charge battery and will not export any power by AC terminal.

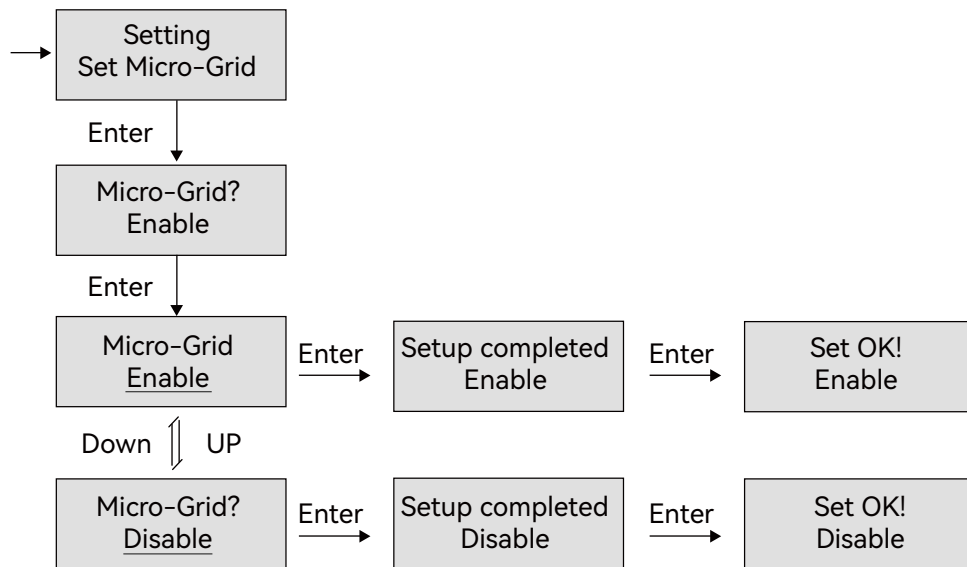

m) Choose master or slave for parallel system

For parallel system, users need to set one inverter to master and others to slave. If the system is single phase, then users need to choose 1 phase master, if the system is three phase, then users need to choose 3 phase master.

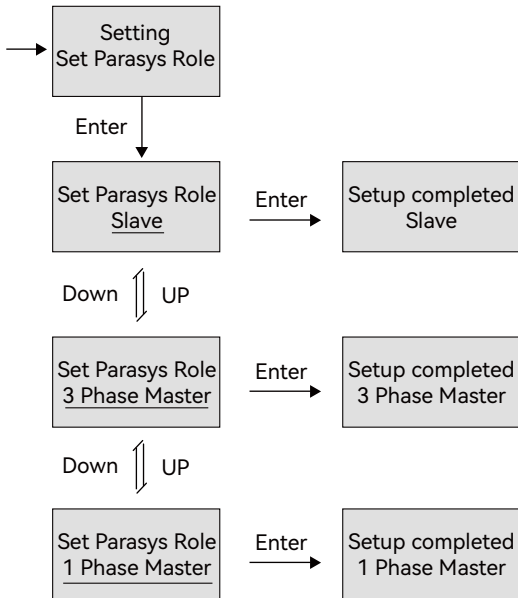

n) Parasys Phase Setting

For parallel system, the inverter is able to detect the phase auto if there is three phase grid input. If the application is pure off grid three phase application, users need to set the phase output for each inverter. For master, it is considered as R phase.

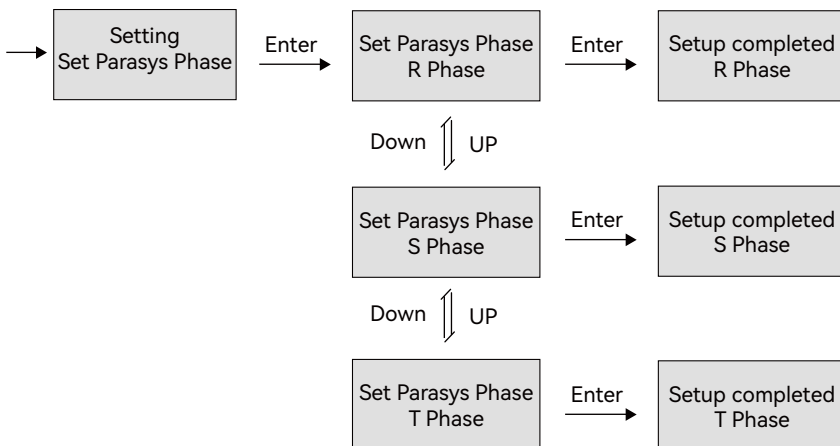

4.3 Monitor System

Users can use wifi dongle/WLAN dongle/4G dongle(Availbale from 2021 March for some countries) to monitor the energy storage system, The monitor website is: server.luxpowertek.com

The APP is also available in the google play and apple APP store(Scan two code bar to download the APP).

Please download the introduction of guidance by website: <https://www.luxpowertek.com/download/>

Document Reference:

1. Wifi Quick Guidance

Quick guidance for setting password for wifi module, the paper is also available in the wifi box

2. Monitor system setup for Distributors and Monitor system setup for endusers

Monitor system registration, wifi password setting, and wifi local monitor and setting

3. Lux_Monitor_UI_Introduction

Introduction of monitor interface

4. WebsiteSettingGuidance

Introduction of website settings for hybrid inverter

4.4 Work with Gen set

All lux units can work with generator.

Users can connect the generator output to inverter Grid terminal. If you have both grid and generator as AC input, we need an external ATS to switch between grid and generator.

Please purchase an external control box to remote turn on/off the generator(which support dry contact function).

The generator will be automatically started when battery voltage is lower than the cut-off value or there is charge request from BMS. When voltage is higher than AC charge setting value, it will stop the generator.

You should enable 'Micro-grid' function via the APP or Web page while you connect the generator to the Lux unit. Battery will get charged when the generator is turned on, and the generator is bypassed to take all loads in AC and UPS terminal.

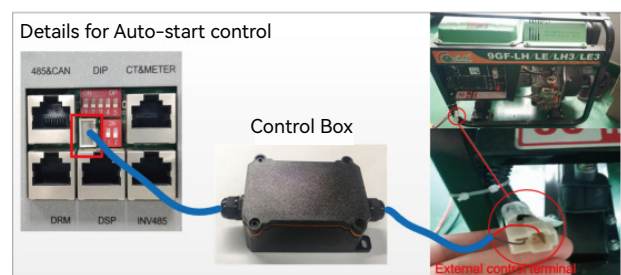
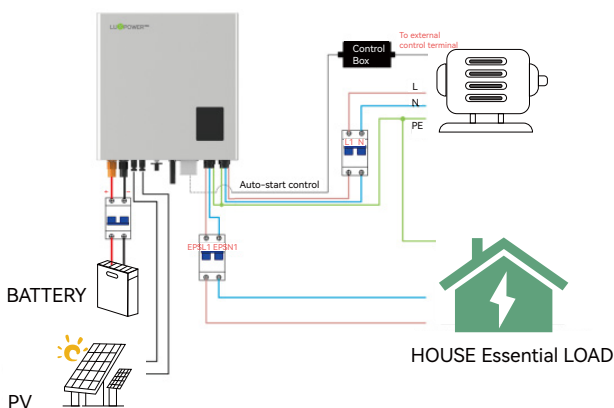

4.5 Parallel system setup guidance

Please note that the parallel model is different from standard model, if users need to connect the UPS together, they need to buy parallel model from distributors.

For parallel system setup,

Step 1. Cable connection :the system connection for single phase paralleling is as below:

the system connection for threephase paralleling is as below:

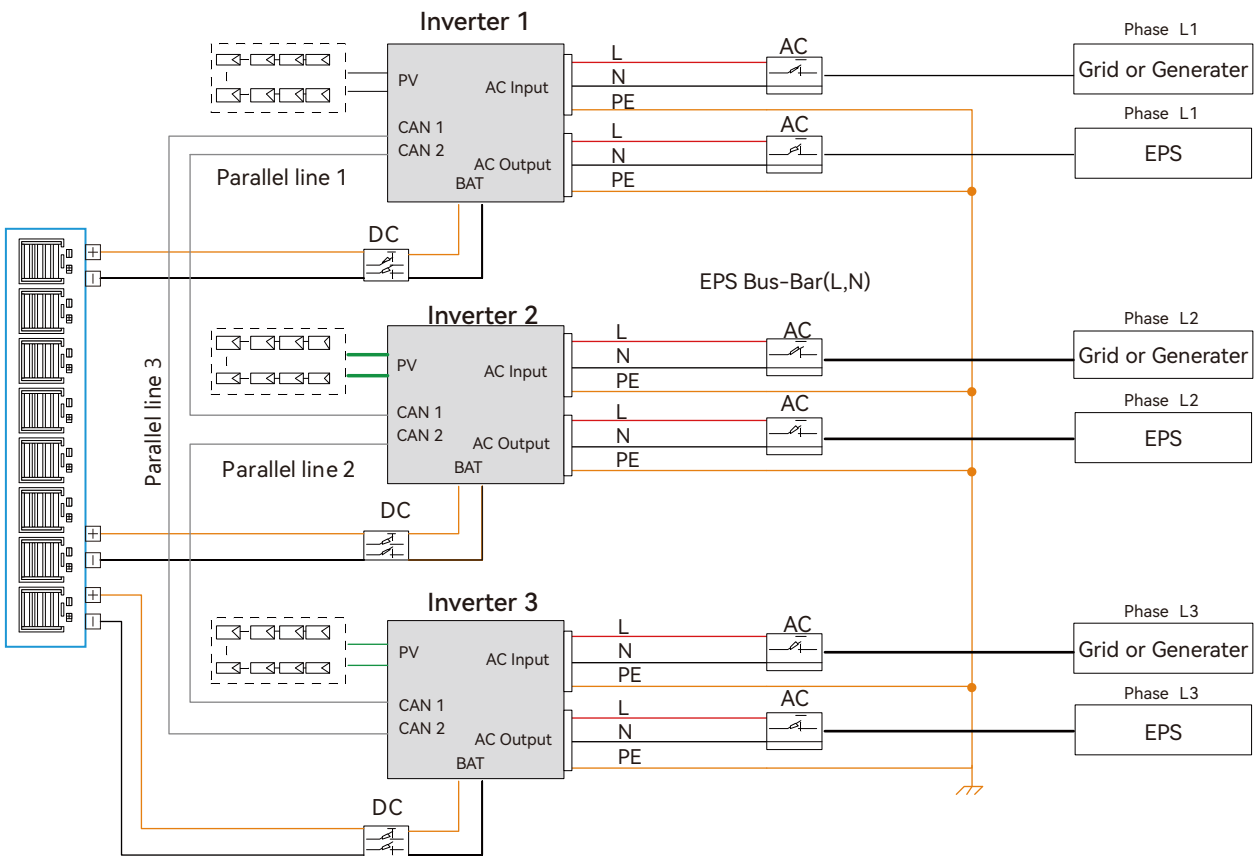
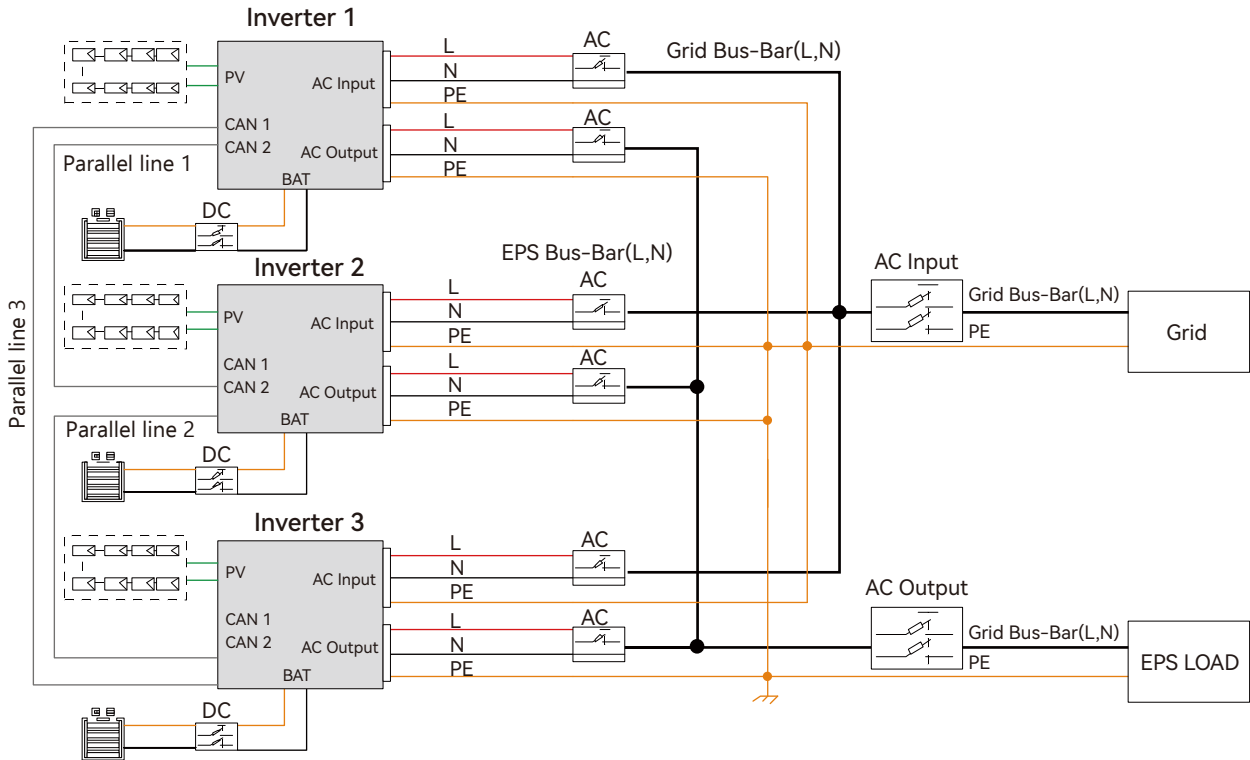

Please put the CAN communication PIN to on status for the first and the end inverter

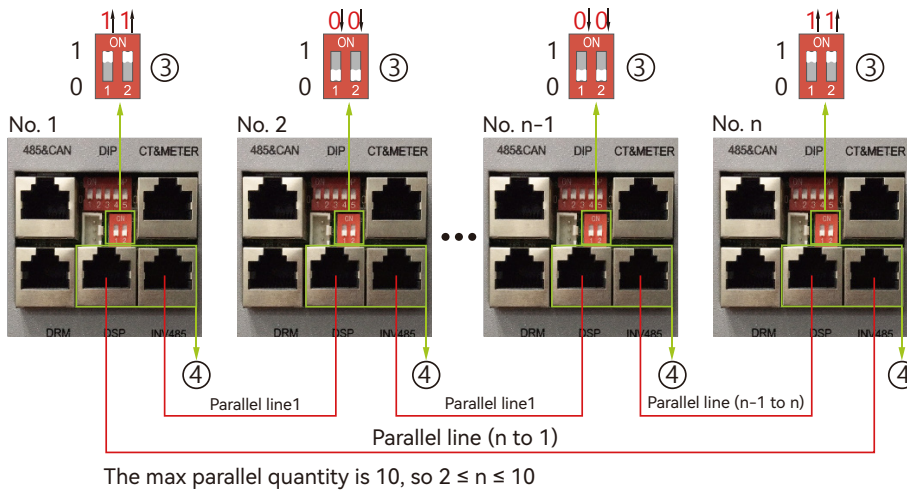

Step 2. Setup the monitor for the system, add all datalogs in one station. Users can login the visit the monitor system, Configuration-> station-> Station Management-> add datalog to add the datalogs.

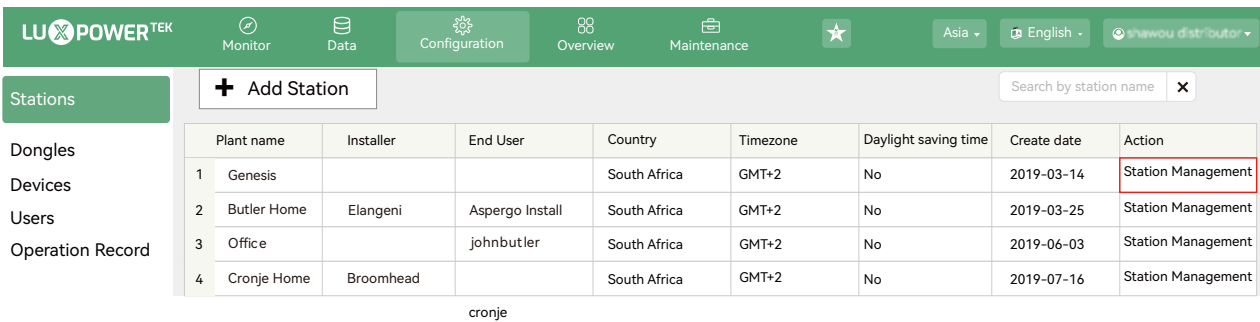

Step 3. Setup Primary and Subordinate for Parallel system. There should be only one primary in the system. Set one inverter as primary and the others as Subordinate.

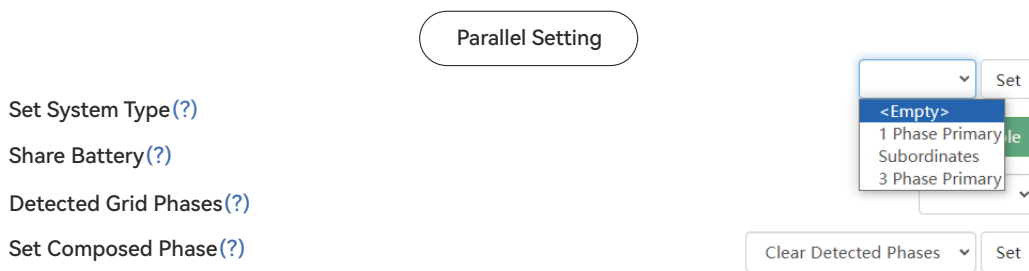

Step 4. Enable share battery for the system if the system share one battery bank, otherwise disable the shared battery function.

Step 5. Set the system as a parallel group in the monitor system

Serial number	Status	Solar Power	Charge Power	Discharge Power	Load	Solar Yield	Battery Dischar	Feed Energy	ConsumptionEr	Station name	Parallel	Action
1 0272011008	Normal	228 W	42 W	0 W	182 W	215.3 kWh	39.6 kWh	0 kWh	551.2 kWh	Dragonview	A-1	Parallel
2 0272011011		35 W	32 W	0 W	0 W	158.7 kWh	21.1 kWh	0 kWh	160.5 kWh	Dragonview	A-2	Parallel
3 0272011012		1 kW	129 W	0 W	1 kW	170.3 kWh	49.9 kWh	0 kWh	434.5 kWh	Dragonview	A-3	Parallel
4 0272011017		79 W	48 W	0 W	106 W	99 kWh	85.6 kWh	0 kWh	257.1 kWh	Dragonview	A-4	Parallel

For more detailed guidance for paralleling system, please visit <https://www.luxpowertek.com/download/> And download the guidance

5. Start-up and shut down the inverter

5.1 start up the inverter

Step 1. Turn on the battery breaker, then turn on "EPS Output" switch and check if the inverter works in battery back-up mode.

Step 2. Make sure the PV voltage of the strings are higher than 120V, and check if the inverter works in PV charge or PV back-up mode.

Step 3. Make sure step1 and 2 above work properly before turning the grid power or generator, and check if the inverter can go to bypass mode and on-grid mode normally.

5.2 Shut down the inverter

Danger: Do not disconnect the battery, PV and AC input power under load.

If there is emergency issue, and you have to shut down the inverter, please follow the steps as below,

Step 1. Cut off AC input breaker of inverter side

Step 2. Cut off the breaker of load side

Step 3. Cut off PV breaker and then cut off the battery, and waiting for the LCD goes off





Step 4. Turn off "Power" switch on the inverter if needed.

6. Troubleshooting & Maintenance

6.1 Troubleshooting

When faults and errors occurred, please deal with these problems following below procedures and requirements.

6.1.1 Introduction to LED Displays

LED	Display	Description	Suggestion
Green LED	Long light 	Working normally	
	Flashing 	Firmware upgrading	Wait till upgrading complete
Yellow LED	Long light 	Warning, inverter working	Need troubleshooting
Red LED	Long light 	Fault, inverter stop work	Need troubleshooting

6.1.2 Maintenance

Every segment of the system need to be check monthly/quarterly/yearly according to the detailed requirements of each segment.

Inverter Maintenance

- a) Check the inverter every 6 months or 1 year to verify if there are damages on cables, accessories, terminals and the inverter itself.
- b) Check the inverter every 6 months to verify if the operating parameter is normal and there is no abnormal heating or noise from the inverter.
- c) Check the inverter every 6 months to confirm there is nothing covers the inverter heat sink, if there is, shut-down the inverter and clear the heat sink.

Battery Maintenance

As per different types battery, from the original manufacturer's requirements on maintenance, when you carried out these works on batteries, please make sure to fully shut-down the inverter for safety consideration.

6.1.3 Troubleshooting Based On LCD Displays

Once there are any warning or fault occurred, the LED and LCD will displays information to remind the operator, the LCD will display relevant error code and short description.

Code	Description	LCD Display	Trouble shooting
E000	Internal communication fault1	E000	Restart inverter, if the error still exist, contact us
E001	Model fault	E001	Check the parallel CAN cables between inverters, and balance resistor is in the right place
E008	Parallel CAN fault	E008	Reset model, check if the safety standard switch is in right place
E009	Primary loss	E009	1. Check the parallel CAN cables between primary to subordinates. and balance resistor is in the right place 2. Check if the parallel system is lack of a primary inverter, and reconfigure a primary.
E010	Multiple Primary	E010	1. Check if the parallel system have two primaries at less. 2. Only allow one primary, reconfigure the others to subordinates.
E011	Parallel AC inconsistent	E011	Check the AC connection between parallel inverters
E012	UPS short circuit	E012	1. Check UPS L,N connection 2. Disconnect the UPS connector, if the error still exist, contact us.
E013	UPS power reversed	E013	Restart the inverter, if the error still exist, contact us.
E015	Parallel phase abnormal	E015	Check the AC connection between triphase parallel system
E016	Relay fault	E016	Restart the inverter, if the error still exist, please contact us.
E017	Internal communication fault 2	E017	Restart the inverter, if the error still exist, please contact us.
E018	Internal communication fault 3	E018	Restart the inverter, if the error still exist, please contact us.
E019	Bus voltage high	E019	Wait for the inverter automatically restart complete, if this error repeats for several times, please contact us
E020	UPS connection fault	E020	Check UPS and AC connections
E021	PV voltage high	E021	Check PV input connection and If PV voltage is in range

Code	Description	LCD Display	Trouble shooting
E022	Over current	E022	Restart inverter, if the error still exist, please contact us
E023	Neutral fault	E023	Check neutral connection
E024	Both PV short circuit	E024	Disconnect both PV connection, if the error still exist, contact us
E025	Temperature over range	E025	Check NTC Connection
E026	Internal fault	E026	Restart inverter, if the error still exist, please contact us
E027	Sampling inconsistent between main and subordinate CPU	E027	Restart inverter, if the error still exist, please contact us
E031	Internal communication fault 4	E031	Restart inverter, if the error still exist, please contact us

Code	Description	LCD Display	Trouble shooting
W000	Communication failure with battery	Bat Com Fault	Check if communication cable is right and have choose the right battery brand, if the warning still exist, contact us
W003	Communication failure with meter	Meter Com Fault	Fix communication cable, if the warning still exist, contact us
W004	Battery failure	Battery failure	Restart battery, if the warning still exist, please contact us and battery manufacture
W005	Auto Test failure	Auto Test failure	Restart inverter, if the warning still exist, please contact us
W016	No AC connection	No AC connection	Check AC connection
W017	AC voltage out of range	AC V Outrange	Check AC grid voltage
W018	AC frequency out of range	AC F Outrange	Check AC grid frequency
W020	PV isolation low	PV Isolation low	Restart inverter, if the error still exist, please contact us
W021	Leakage current high	Leakage I high	Restart inverter, if the error still exist, please contact us
W022	DC injection high	DC Injection high	Restart inverter, if the error still exist, please contact us
W023	PV short circuit	PV short	Check and fix PV input connection
W025	Battery voltage high	Bat Volt High	Check and fix battery connection
W026	Battery voltage low	Bat Volt Low	Check and fix battery connection
W027	Battery open circuit	Bat open	Check and fix battery connection
W028	UPS over load	UPS Over Load	Check and adjust UPS load
W030	Meter connection reversed	Meter Reversed	Check and fix meter connection

Solar Input	3K Hybrid	3.6K Hybrid	4K Hybrid	4.6K/5K Hybrid	6K/Hybrid
Max. DC Input Power	6600W	7000W	7000W	8000W	8000W
Nominal DC Input Voltage	360V.d.c	360V.d.c	360V.d.c	360V.d.c	360V.d.c
DC Input Voltage Range	100-550V.d.c	100-550V.d.c	100-550V.d.c	100-550V.d.c	100-550V.d.c
MPPT Voltage Range	120-500V.d.c	120-500V.d.c	120-500V.d.c	120-500V.d.c	120-500V.d.c
Start-up Voltage	140V.d.c	140V.d.c	140V.d.c	140V.d.c	140V.d.c
MPPT Number	2	2	2	2	2
Max. DC Input Current	13.5A/13.5A	13.5A/13.5A	13.5A/13.5A	13.5A/13.5A	13.5A/13.5A
Max. Short-circuit Current	20A/20A	20A/20A	20A/20A	20A/20A	20A/20A
Max. Input Power per MPPT	3600W/3600W	4000W/4000W	4000W/4000W	4000W/4000W	4000W/4000W
Max. Feedback Current to Array	0/0 A	0/0 A	0/0 A	0/0 A	0/0 A

Battery Output

Battery Output	Lithium-ion/Lead-Acid	Lithium-ion/Lead-Acid	Lithium-ion/Lead-Acid	Lithium-ion/Lead-Acid	Lithium-ion/Lead-Acid
Compatible Battery Type	Lithium-ion/Lead-Acid	Lithium-ion/Lead-Acid	Lithium-ion/Lead-Acid	Lithium-ion/Lead-Acid	Lithium-ion/Lead-Acid
Nominal Battery Voltage	48V.d.c	48V.d.c	48V.d.c	48V.d.c	48V.d.c
Battery Voltage Range	40-60V.d.c	40-60V.d.c	40-60V.d.c	40-60V.d.c	40-60V.d.c
Max. Charge/Discharge Current	66A/66A	66A/66A	80A/80A	80A/80A	80A/80A
Max. Charge/Discharge Power	3600W/3600W	3600W/3600W	3600W/3600W	3600W/3600W	4000W/4000W
Charging Curve	3 stages	3 stages	3 stages	3 stages	3 stages
Max. Charge Voltage	59V	59V	59V	59V	59V
DOD(Lithium-ion/Lead-Acid)	80%/50%	80%/50%	80%/50%	80%/50%	80%/50%
Capacity of Battery	2-20kWh	2-20kWh	2-20kWh	2-20kWh	2-20kWh

AC Output

Nominal AC Output Power	3000W	3600W	4000W	4600W/5000W	6000W
Max. AC Output Power	3000VA	3600VA	4000VA	4600VA/5000VA	6000VA
Max. AC Output Current	15A	16A	20A	25A	26A
Nominal AC Voltage	230V.a.c	230V.a.c	230V.a.c	230V.a.c	230V.a.c
AC Voltage Range	180-270V.a.c	180-270V.a.c	180-270V.a.c	180-270V.a.c	180-270V.a.c
Nominal AC Frequency	50Hz/60Hz	50Hz/60Hz	50Hz/60Hz	50Hz/60Hz	50Hz/60Hz
AC Frequency Range	45-55Hz/55-65Hz	45-55Hz/55-65Hz	45-55Hz/55-65Hz	45-55Hz/55-65Hz	45-55Hz/55-65Hz
Power Factor	Adjustable 0.8 overexcited to 0.8 underexcited	Adjustable 0.8 overexcited to 0.8 underexcited	Adjustable 0.8 overexcited to 0.8 underexcited	Adjustable 0.8 overexcited to 0.8 underexcited	Adjustable 0.8 overexcited to 0.8 underexcited
THDI	<3%	<3%	<3%	<3%	<3%
Inrush Current	10A/10us	10A/10us	10A/10us	10A/10us	10A/10us
Max. Output Fault Current	50A/20us	50A/20us	50A/20us	50A/20us	50A/20us
Max. Output Over Current Protect	15A	20A	20A	25A	26A

UPS Output - with Battery

UPS Max. Output Power without Solar	3600W	3600W	3600W	4000W
UPS Max. Output Power with Solar	5000W	5000W	5000W	6000W
UPS Nominal Output Voltage	230V.a.c	230V.a.c	230V.a.c	230V.a.c
UPS Nominal Output Frequency	50Hz/60Hz	50Hz/60Hz	50Hz/60Hz	50Hz/60Hz
UPS Nominal Output Current	13A	13A	13A	17.4A
Peak Power	4500W, 30s	4500W, 30s	4500W, 30s	4500W,30s
THDV	<5%	<5%	<5%	<5%
Switching Time	<0.01s	<0.01s	<0.01s	<0.01s

Efficiency

Europe Efficiency	97.5%	97.5%	97.5%	97.5%
Max. Efficiency	97.9%	97.9%	97.9%	97.9%
Battery Charge/Discharge Efficiency	94.5%	94.5%	94.5%	94.5%

Protection

Reverse Polarity Protection	Yes	Yes	Yes	Yes
Over Current/Voltage Protection	Yes	Yes	Yes	Yes
Anti-islanding Protection	Yes	Yes	Yes	Yes
AC Short-circuit Protection	Yes	Yes	Yes	Yes
Leakage Current Protection	Yes	Yes	Yes	Yes
Ground Fault Monitoring	Yes	Yes	Yes	Yes
Grid Monitoring	Yes	Yes	Yes	Yes
Ingress Protect Degree	IP65/NEMA4X	IP65/NEMA4X	IP65/NEMA4X	IP65/NEMA4X
DC Switch	Yes	Yes	Yes	Yes

General Data

Dimensions (W/H/D)	451/469(551)/184	451/469(551)/184	451/469(551)/184	451/469(551)/184
Weight	20kg	20kg	20kg	20kg
Topology	Transformerless(solar), HF(Battery)	Natural Convection	Natural Convection	Transformerless(solar), HF(Battery)
Cooling Concept	Natural Convection	Natural Convection	Natural Convection	Natural Convection
Relatively Humidity	0-100%	0-100%	0-100%	0-100%
Operating Temperature Range	-25-60°C	-25-60°C	-25-60°C	-25-60°C
Altitude	<2000m	<2000m	<2000m	<2000m
Noise Emission	<25dB	<25dB	<25dB	<25dB
Standby Consumption	<5W	<5W	<5W	<5W
Display & Communication Interfaces	LCD, LED, RS485, Wi-Fi, CAN	LCD, LED, RS485, Wi-Fi, CAN	LCD, LED, RS485, Wi-Fi, CAN	LCD, LED, RS485, Wi-Fi, CAN

Certification & Approvals

AS 4777, VDE-AR-N4105, VDE0126, G83, G59, NRS 097-2-1
IEC62109-1-2, IEC62040, EN61000-6-1, EN61000-6-2, EN61000-6-3

Solar Input

Max. DC Input Power 7000W
 Nominal DC Input Voltage 360V.d.c
 DC Input Voltage Range 100-550V.d.c
 MPPT Voltage Range 120-500V.d.c
 Start-up Voltage 140V.d.c
 MPPT Number 2
 Max. DC Input Current 13.5A/13.5A

LXP4K HB

8000W
 360v.d.c
 100-550V.d.c
 120-500V.d.c
 140v.d.c
 2
 13.5A/13.5A

LXP5K HB

8000W
 360V.d.c
 100-550V.d.c
 120-500V.d.c
 140V.d.c
 2
 13.5A/13.5A

LXP6K HB

Battery input/output

Compatible Battery Type Lithium-ion/Lead-Acid
 Nominal Battery Voltage 250V.d.c
 Battery Voltage Range 90-450V.d.c
 Max.Charge/Discharge Current 20A/20A
 Max.Charge/Discharge Power 4000W/4000W
 Charging Curve 3-stages

Lithium-ion/Lead-Acid
 250V.d.c
 90-450V.d.c
 20A/20A
 5000w/5000W
 3-stages

Lithium-ion/Lead-Acid
 250V.d.c
 90-450V.d.c
 25A/25A
 6000W/6000W
 3-stages

AC Input/Output

Nominal AC Output Power 4000W
 Nominal AC Output Current 17.5A
 Max. AC Output Current 22A
 Nominal AC Voltage 230V
 Optional AC Voltage Range 180~270Vac
 Nominal AC Frequency 50Hz/60Hz
 AC Frequency Range 45-55Hz/55-65Hz
 Power Factor >0.99@rated power 0.8 lagging-0.8 leading Adjustable
 THDI < 3%

5000W
 21.7A
 27A
 230V
 180~270Vac
 50Hz/60Hz
 45-55Hz/55-65Hz
 >0.99@rated power 0.8 lagging-0.8 leading Adjustable
 <3%

6000W
 26A
 30A
 230V
 180~270Vac
 50Hz/60Hz
 45-55Hz/55-65Hz
 <3%

UPS Output - with Battery

UPS Nominal Power 4000W
 UPS Nominal Voltage 230Vac
 UPS Nominal Frequency 50Hz/60Hz
 UPS Nominal Current 17.5A
 Peak Power 5000w, 30s
 THDV <3%@R-load
 Switching Time Typical 0.01s

5000W
 230Vac
 50Hz/60Hz
 21.7A
 6200w, 30s
 <3%@R-load
 Typical 0.01s

6000W
 230Vac
 50Hz/60Hz
 26A
 6900w, 30s
 <3%@R-load
 Typical 0.01s

Efficiency				
Europe Efficiency	96.3%	96.3%	96.3%	96.3%
Max. Efficiency	97.5%	97.5%	97.5%	97.5%
Max. Charge/Discharge Efficiency	97%/ 96.6%	97%/ 96.6%	97%/ 96.6%	97%/ 96.6%
Protection				
Reverse Polarity Protection	Yes	Yes	Yes	Yes
Over Current/Voltage Protection	Yes	Yes	Yes	Yes
Anti-islanding Protection	Yes	Yes	Yes	Yes
AC Short-circuit Protection	Yes	Yes	Yes	Yes
Leakage Current Protection	Yes	Yes	Yes	Yes
Ground Fault Monitoring	Yes	Yes	Yes	Yes
Grid Monitoring	Yes	Yes	Yes	Yes
Ingress Protect Degree	IP65/NEMA4X	IP65/NEMA4X	IP65/NEMA4X	IP65/NEMA4X
DC Switch	Integrated	Integrated	Integrated	Integrated
General Data				
Dimensions (w/H/D)	455/476(565)/181	455/476(565)/181	455/476(565)/181	455/476(565)/181
Weight	20 kg	20 kg	20 kg	20 kg
Topology	Transformerless	Transformerless	Transformerless	Transformerless
Cooling Concept	Natural Convection	Natural Convection	Natural Convection	Natural Convection
Relatively Humidity	0-100%	0-100%	0-100%	0-100%
Operating Temperature Range	-25-60	-25-60	-25-60	-25-60
Altitude	<2000m	<2000m	<2000m	<2000m
Noise Emission	<25dB	<25dB	<25dB	<25dB
Standby Consumption	<10W	<10W	<10W	<10W
Display/Communication Interface	LCD/LED/RS485/Wi-Fi/CAN	LCD/LED/RS485/Wi-Fi/CAN	LCD/LED/RS485/Wi-Fi/CAN	LCD/LED/RS485/Wi-Fi/CAN
Certification & Approvals				
		CEI 0-21		
		IEC62109-1-2, IEC62040, EN61000-6-1, EN61000-6-2, EN61000-6-3		

■ YOUR RELIABLE ENERGY SOLUTIONS PARTNER



Lux Power Technology Co., Ltd
Headquarter: +86 755 8520 9056
www.luxpowertek.com
Contact us: info@luxpowertek.com



092.20021AA